

- PL Instrukcja montażu
 DE Montageanleitung
 NL Handleiding voor de montage
 TR Montaj talimatı
 FR Notice de montage
 CZ Montážní návod
 HU Szerelési útmutató
 GB Assembly instructions
 RU Инструкция по монтажу
 IT Istruzioni di montaggio
 SK Návod na montáž
 RO Instrucțiuni de montaj
 ES Instrucciones de montaje
 PT Instruções de montagem

Producent - Produzent - Üretici - Producteur - Výrobce -
 Termelő - Producer - Produttore - Producător - Productor
MEBLE LASKI KACZOROWSKA SP.K.
 Laski, ul. Kępińska 21, 63-620 Trzcinica
 meble-laski@meble-laski.com.pl

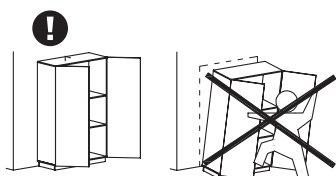

2026-02-25

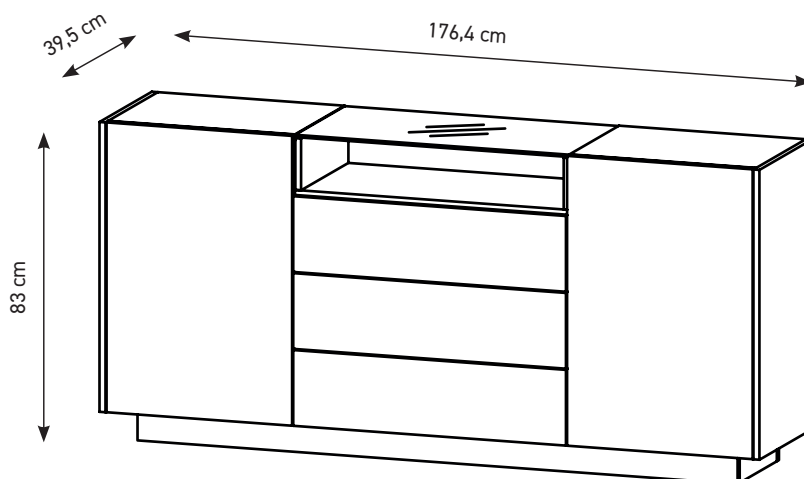
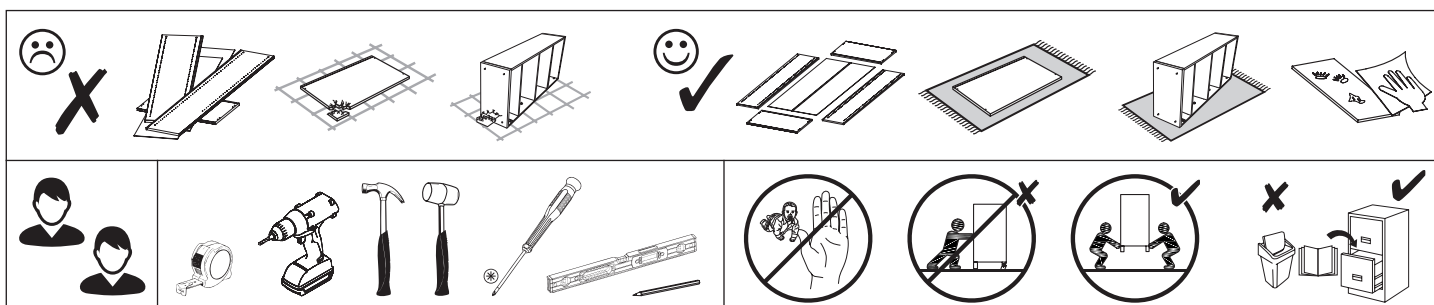

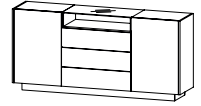

PL Przed rozpoczęciem montażu mebla wszystkie elementy należy sprawdzić czy nie są uszkodzone. W przypadku wykrycia uszkodzenia elementu należy odstąpić od montażu mebla i złożyć reklamację. Nie wolno przekraczać podanych maksymalnych wartości obciążenia. W innym przypadku można mebel uszkodzić lub zniszczyć.

Przed zawieszeniem mebla, lub przymocowaniem go do ściany (w celu zabezpieczenia przed przewróceniem), sprawdź wcześniej rodzaj i wytrzymałość ściany. Dobierz odpowiednie kotki i wkręty do rodzaju ściany. W przypadku wątpliwości skontaktuj się ze specjalistą. Montaż musi zostać wykonany przez osobę kompetentną. Meble zawierające płyty drewnopochodne mogą emitować substancje zanieczyszczające do powietrza w pomieszczeniu. Dlatego zaleca się, po zamontowaniu mebli, częste wietrzenie pomieszczenia przez co najmniej cztery tygodnie.

DE Vor Beginn der Möbelmontage sollten alle Elemente auf Beschädigungen überprüft werden. Wenn ein Element des Produkts beschädigt ist, installieren Sie das Produkt bitte nicht und reichen Sie eine Beschwerde ein. Überschreiten Sie die angegebenen Maximalbelastungen nicht. Andernfalls kann das Möbelstück beschädigt oder zerstört werden.

Bevor Sie ein Möbelstück an einer Wand aufhängen oder befestigen (um es gegen Umkippen zu sichern), prüfen Sie Art und Tragfähigkeit der Wand. Wählen Sie die für die Wand geeigneten Dübel und Schrauben. Im Zweifelsfall kontaktieren Sie bitte einen Fachmann. Die Montage muss durch eine sachkundige Person ausgeführt werden. Möbel mit Holzwerkstoffplatten können Schadstoffe in die Raumluft abgeben, daher Es wird empfohlen, den Raum nach dem Einbau der Möbel mindestens vier Wochen lang häufig zu lüften.

FR Avant de commencer l'assemblage du meuble, tous les éléments doivent être vérifiés pour détecter tout dommage. Si un élément du produit est endommagé, veuillez ne pas installer le produit et déposer une plainte. Ne dépassez pas les charges maximum indiquées. Sinon, le meuble peut être endommagé ou détruit.

Avant de suspendre le meuble ou de le fixer au mur (dans le but d'éviter un renversement), vérifiez au préalable le type et la résistance du mur. Utilisez les chevilles et les vis adaptées au type de mur. En cas de doute, veuillez contacter un spécialiste. Le montage doit être réalisé par une personne compétente. Les meubles contenant des panneaux à base de bois peuvent émettre des substances polluantes dans l'air intérieur. Donc il est recommandé, après l'installation des meubles, d'aérer fréquemment la pièce pendant au moins quatre semaines.

CZ Před zahájením montáže nábytku je třeba zkontrolovat poškození všech prvků. Pokud je některý prvek produktu poškozen, zdržte se instalace produktu a podejte stížnost. Nepřekračujte uvedené maximální zatížení. V opačném případě může dojít k poškození nebo zničení nábytku.

Před zavěšením nábytku nebo jeho připevněním ke zdi (za účelem zajištění před převrácením) dříve zkontrolujte druh a odolnost stěny. Vyberte k druhu stěny vhodné hmoždinky a šrouby. V případě pochybností kontaktujte specialistu. Montáž musí být provedena kompetentní osobou. Nábytek obsahující panely na bázi dřeva může uvolňovat znečišťující látky do vnitřního ovzduší. Proto doporučuje se po instalaci nábytku místnost pravidelně větrat po dobu nejméně čtyř týdnů.

HU A bútor szerelés megkezdése előtt ellenőrizni kell az összes elem sérülését. Ha a termék bármely eleme megsérült, kérjük, tartózkodjon a termék telepítésétől és nyújtson be panaszt. A megadott maximális terhelési értékeket nem szabad túllépni. Ellenkező esetben a bútor megsérülhet vagy megsemmisülhet.

A bútor felfüggesztése illetve falhoz való rögzítése (megakadályozván ezzel eldőlésének lehetőségét) előtt ellenőrizze a fal fajátékát és szilárdságát. Megfelelő, a falhoz illő tipliket és csavarokat használjon. Ha kétsége támadna, konzultáljon szakemberrel. A felszerelés csak egy hozzáértő szakember végezheti el. A fa alapú paneleket tartalmazó bútorok szennyező anyagokat bocsáthatnak ki a beltéri levegőbe. Ezért Ajánlott a bútorok beszerelése után legalább négy hétig rendszeresen szellőztetni a helyiséget.

GB Before starting the furniture assembly, all elements should be checked for damage. If any element of the product is damaged, please refrain from installing the product and file a complaint. The specified maximum load values must not be exceeded. Otherwise, the piece of furniture may be damaged or destroyed.

Before suspending or fixing furniture to the wall (in order to prevent falling over), check the type and strength of the wall. Select wall plugs and screws appropriate for the given type of the wall. In the case of doubts, contact a specialist. The installation must be performed by a competent person. Furniture containing wood-based panels can emit polluting substances into the indoor air. Therefore recommended, after installing the furniture, to ventilate the room frequently for at least four weeks.

SK Pred začatím montáže nábytku by sa mali skontrolovať všetky prvky, či nie sú poškodené. Ak je ktorýkoľvek prvok výrobku poškodený, neinstalujte výrobok a reklamujte ho. Uvedené hodnoty maximálneho zaťaženia nesmú byť prekročené. V opačnom prípade môže dôjsť k poškodeniu alebo zničeniu nábytku.

Pred zavesením nábytku alebo jeho pripavením na stenu (za účelom zaistenia pred prevrátením) predtým skontrolujte druh a odolnosť steny. Vyberte k druhu steny vhodné hmoždinky a skrutky. V prípade pochybností kontaktujte špecialistu. Montáž musí byť vykonaná kompetentnou osobou. Nábytok obsahujúci dosky na báze dreva môže vyľučovať znečisťujúce látky do vnútorného ovzdušia. Preto odporúča sa po inštalácii nábytku miestnosť pravidelne vetrať aspoň štyri týždne.

IT Prima di iniziare l'assemblaggio del mobile, tutti gli elementi dovrebbero essere controllati per danni. Se qualche elemento del prodotto è danneggiato, astenersi dall'installare il prodotto e presentare un reclamo. I valori di carico massimo specificati non devono essere superati. In caso contrario, il mobile potrebbe essere danneggiato o distrutto.

Prima di appendere i mobili, oppure attaccarli al muro (per proteggerli da ribaltamenti), verifica prima la tipologia e resistenza del muro. Scegli i tasselli e viti più adatti per il tipo di muro. In caso di dubbi contattare uno specialista. Il montaggio deve essere fatto da una persona competente.

I mobili contenenti pannelli a base di legno possono emettere sostanze inquinanti nell'aria interna. Perciò si consiglia, dopo aver installato i mobili, di aereare frequentemente il locale per almeno quattro settimane.

NL Voordat u met de meubelmontage begint, moeten alle elementen op schade worden gecontroleerd. Als een onderdeel van het product beschadigd is, installeer het dan niet en dien een klacht in. Overschrijd de aangegeven maximale belastingen niet. Anders kan het meubelstuk worden beschadigd of vernield.

Voordat u het meubel ophangt of bevestigt tegen de muur (om het te beschermen tegen omvallen) dient u het type en de duurzaamheid van deze muur na te kijken. Maak gebruik van pluggen en schroeven die geschikt zijn voor het type muur. Neem in geval van twijfels contact op met een specialist. De assemblage dient te worden uitgevoerd door iemand met kennis van zaken.

Meubels met panelen of houtbasis kunnen vervuilende stoffen in de binnenlucht uitstoten. Daarom Het is raadzaam om na het plaatsen van het meubilair de ruimte minimaal vier weken regelmatig te ventileren.

TR Mobilya montajına başlamadan önce tüm elemanlarda hasar olup olmadığını kontrol edilmelidir. Ürünün herhangi bir parçası hasar görmüşse, lütfen ürünü kurmayın ve şikayette bulunun.

Belirtilen azami yük değerini aşmayınız, aksi takdirde mobilya parçaları zarar görebilir veya kullanılamaz hale gelebilir.

Mobilyayı duvara asmadan veya montaj etmeden önce (devrilmesini önlemek için) duvarın türünü ve dayanıklılığını kontrol edin. Duvara uygun dübelleri ve vidaları seçin. Emin olamamanız durumunda bir uzman ile iletişime geçin.

Kurulum yetkilisi bir kişi tarafından yapılmalıdır. Aşağı bazı paneller içeren mobilyalar iç mekan havasına kirlenici maddeler yayabilir. Öyleyse Mobilyaların kurulumundan sonra odanın en az dört hafta boyunca sık sık havalandırılması önerilir.

RO Înainte de a începe asamblarea mobilierului, toate elementele trebuie verificate pentru a nu se deteriorează. Dacă vreun element al produsului este deteriorat, vă rugăm să vă abțineți de la instalarea produsului și să depuneți o reclamație.

Valoriile maxime de sarcină specificate nu trebuie depășite. În caz contrar, piesa de mobilier poate fi deteriorată sau distrusă.

Înainte de suspendarea unei piese de mobilier sau atașarea acestuia la perete (pentru a preveni bascularea), verificați în prealabil tipul și gradul de rezistență a peretelui. Montați dibururile și șuruburile adecvate pentru tipul de perete. În caz de îndoieli, consultați un specialist. Instalarea trebuie să fie efectuată de către o persoană competentă.

Mobilierul care conține panouri pe bază de lemn poate emite substanțe poluante în aerul interior. Prin urmare se recomandă ca, după montarea mobilierului, aerisirea frecventă a încăperii timp de cel puțin patru săptămâni.

ES Antes de comenzar el montaje de los muebles, todos los elementos deben comprobarse en busca de daños. Si algún elemento del producto está dañado, absténgase de instalar el producto y presente una queja. No se deben exceder los valores de carga máxima especificados. De lo contrario, el mueble puede dañarse o destruirse.

Antes de colgar o fijar el mueble en el muro (a fin de proteger contra el vuelco del mueble), compruebe de antemano la naturaleza y la resistencia de la pared. Seleccione tacos y tornillos adecuados para el tipo de la pared. En caso de duda, consulte a un especialista, debiendo efectuar este montaje una persona competente.

Los muebles que contienen paneles de madera pueden emitir sustancias contaminantes al aire interior. Por lo tanto se recomienda, después de instalar los muebles, ventilar la habitación con frecuencia durante al menos cuatro semanas.

PT Antes de iniciar a montagem do móvel, todos os elementos devem ser verificados quanto a danos. Se algum elemento do produto estiver danificado, evite instalar o produto e apresente uma reclamação. Os valores de carga máxima especificados não devem ser excedidos. Caso contrário, o móvel pode ficar danificado ou destruído.

Antes de suspender ou fixar móveis à parede (para evitar quedas), verifique o tipo e a resistência da parede. Seleccione buchas e parafusos adequados ao tipo de parede. Em caso de dúvida contacte um especialista. A instalação deve ser realizada por uma pessoa competente.

Os móveis que contenham painéis de madeira podem emitir substâncias poluentes para o ar interior. Assim, recomenda-se, após a instalação dos móveis, ventilar o ambiente frequentemente durante pelo menos quatro semanas.

RU Прежде чем приступить к сборке мебели, следует проверить все элементы на предмет повреждений. Если какой-либо элемент продукта поврежден, воздержитесь от установки продукта и подайте жалобу.

Указанные максимальные значения нагрузки превышать нельзя. В противном случае предмет мебели может быть поврежден или разрушен.

Прежде чем подвешивать или крепить мебель к стене (во избежание падения), проверьте тип и прочность стены. Выбирайте дюбели и шурупы, подходящие для данного типа стены. В случае сомнений обратитесь к специалисту. Установка должна выполняться компетентным лицом.

Мебель, состоящая из древесных плит, может выделять загрязняющие вещества в воздух в помещении. Поэтому рекомендуется после установки мебели часто проветривать помещение в течение как минимум четырех недель.

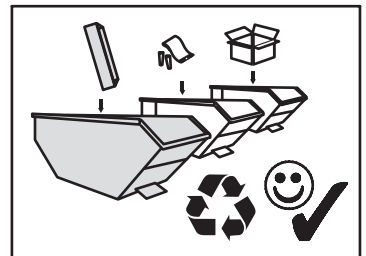
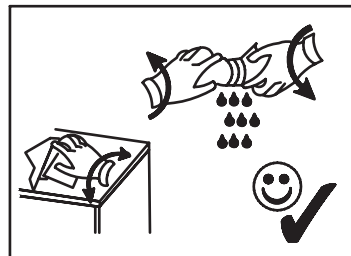
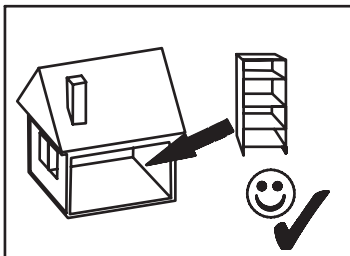
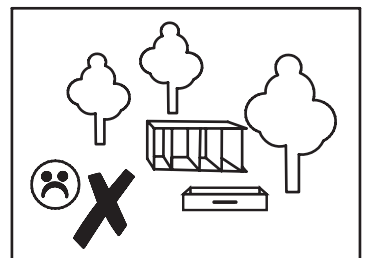
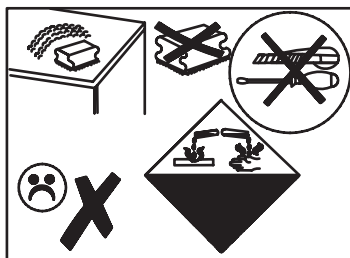
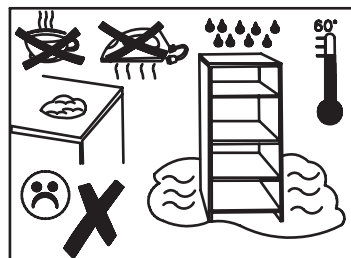
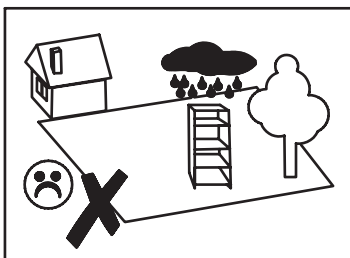

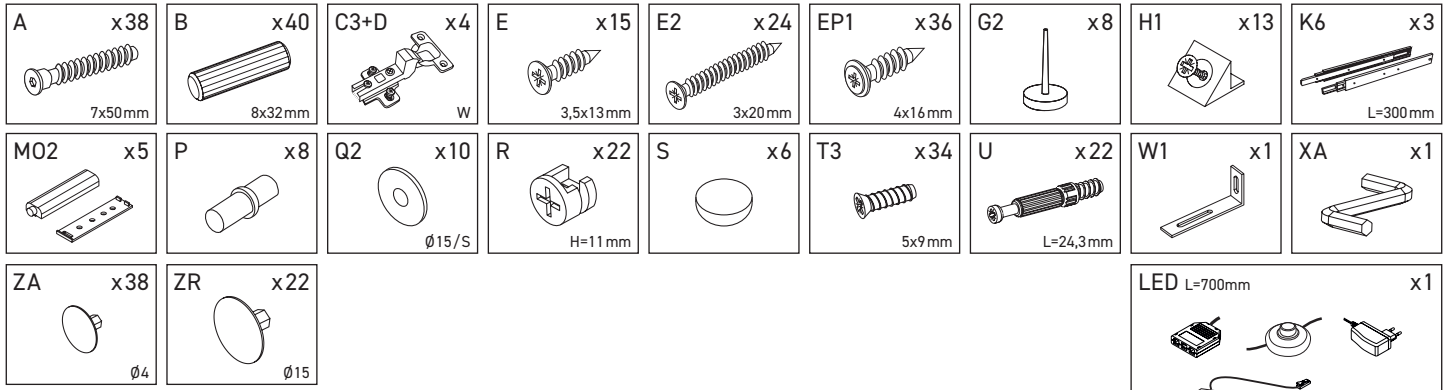
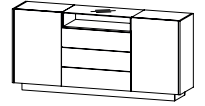

C-1	734	374	16	x 1	2/2
C-2	133	357	16	x 2	1/2
C-3	734	133	16	x 1	1/2
C-4	499	374	16	x 1	2/2
C-5	499	374	16	x 1	2/2
C-6	1732	353	16	x 1	1/2
C-7	746	395	16	x 1	2/2
C-8	746	395	16	x 1	2/2
C-9	714	353	16	x 1	1/2
C-10	714	353	16	x 1	1/2
C-11	734	90	16	x 1	2/2
C-12	496	746	16	x 2	2/2
C-13	728	195	16	x 3	1/2
C-14	300	120	16	x 3	1/2
C-15	300	120	16	x 3	1/2
C-16	678	120	16	x 2	1/2
C-16	678	120	16	x 1	2/2
C-17	708	306	3	x 3	1/2
C-18	483	330	16	x 2	1/2
C-19	1604	80	16	x 2	1/2
C-20	280	80	16	x 2	1/2
C-21L	736	499	3	x 1	2/2
C-21R	736	499	3	x 1	2/2
C-22	594	746	3	x 1	1/2
C-23	732	374	6	x 1	2/2

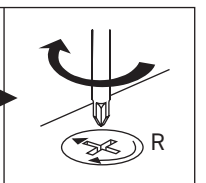
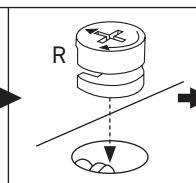
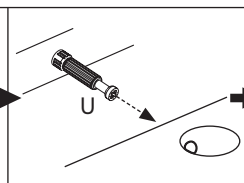
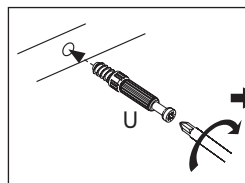
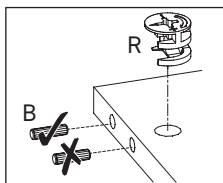
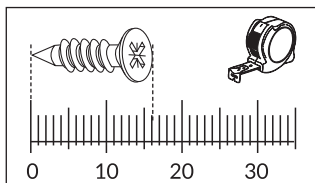
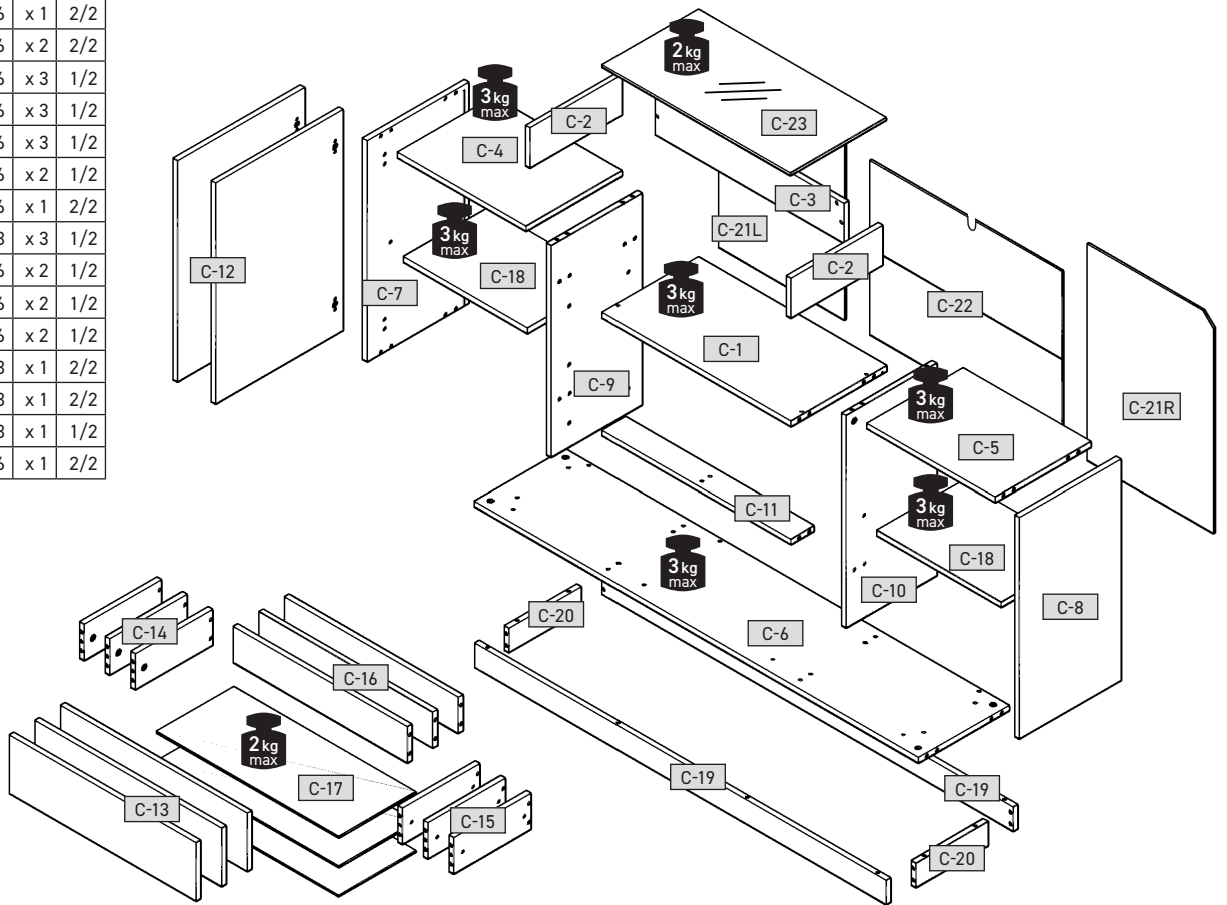

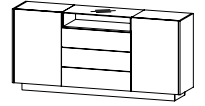

1

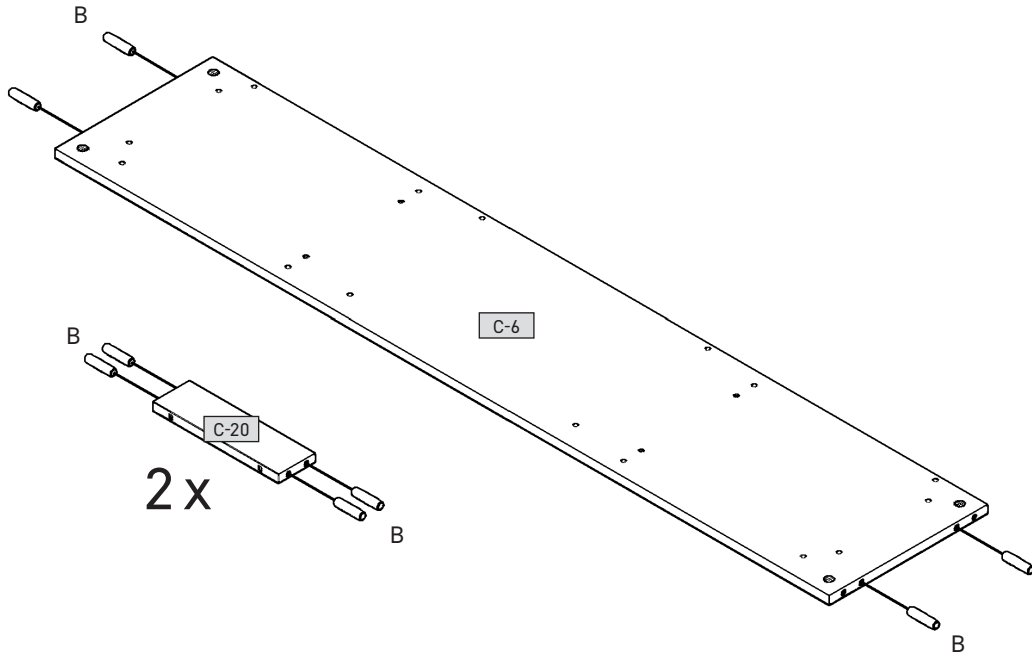
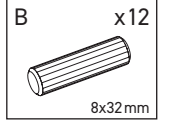

2

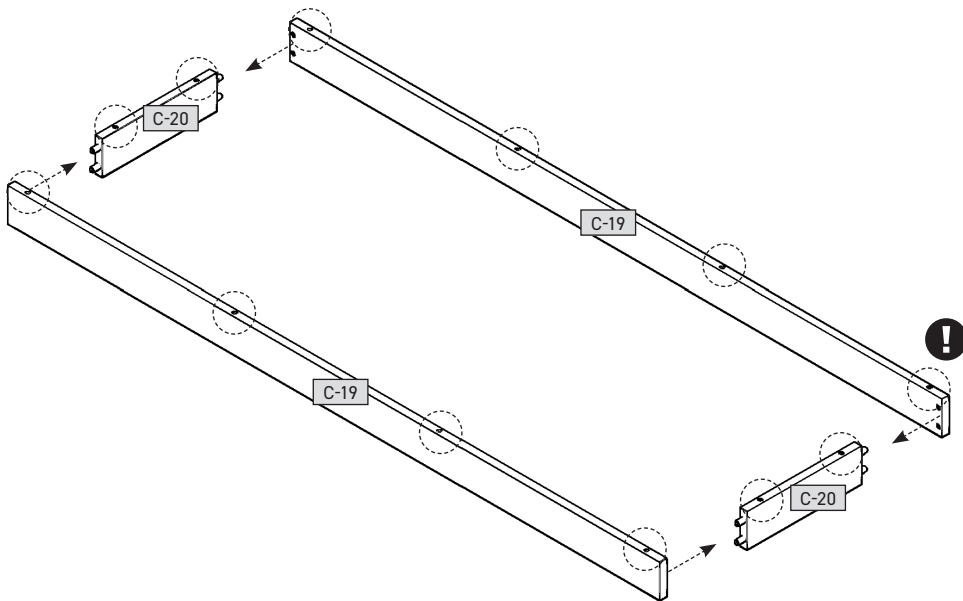

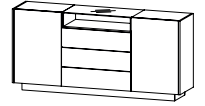

3

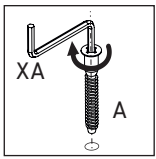
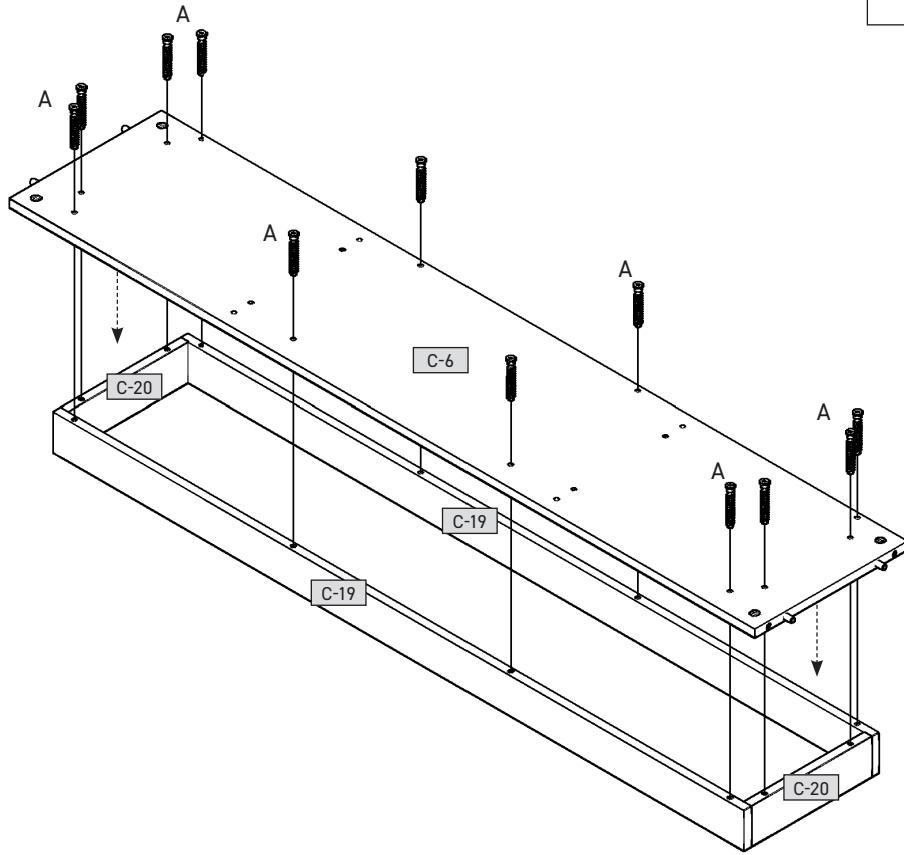
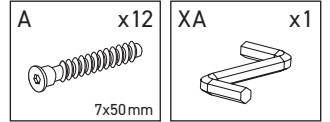

4

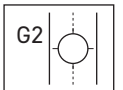
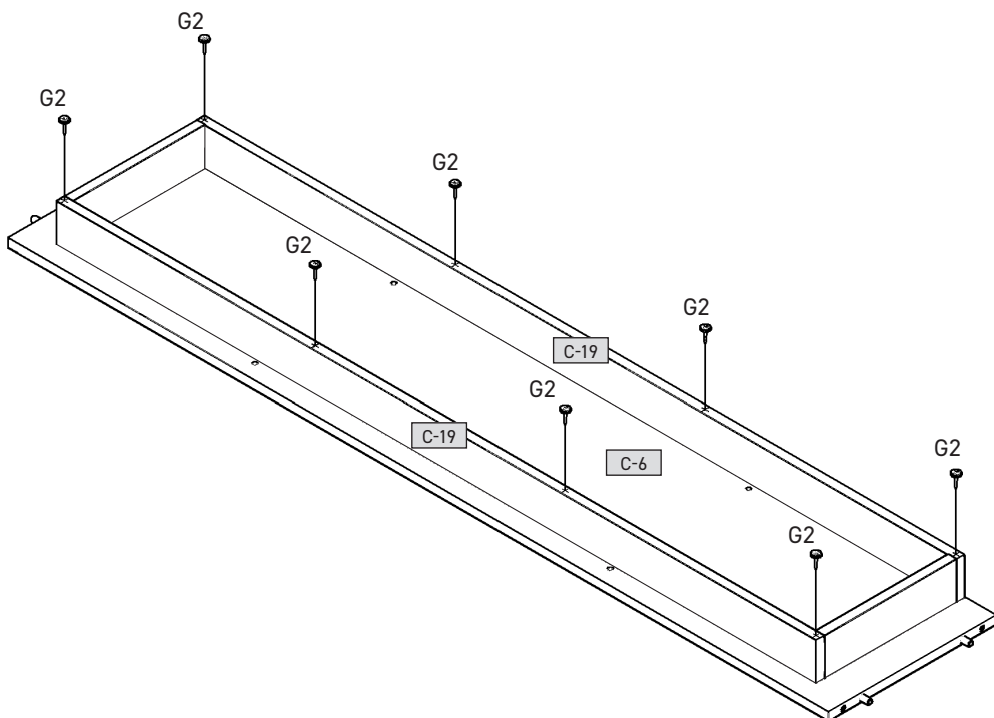
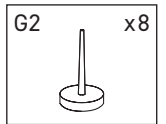

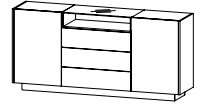

5



B x8 8x32mm	M02 x5	U x4 L=24,3mm	T3 x10 5x9mm
-----------------------	---------------	-------------------------	------------------------

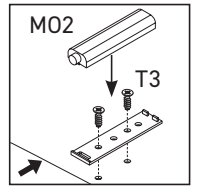
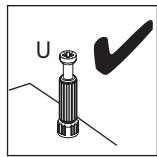
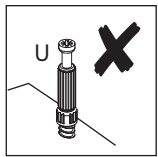
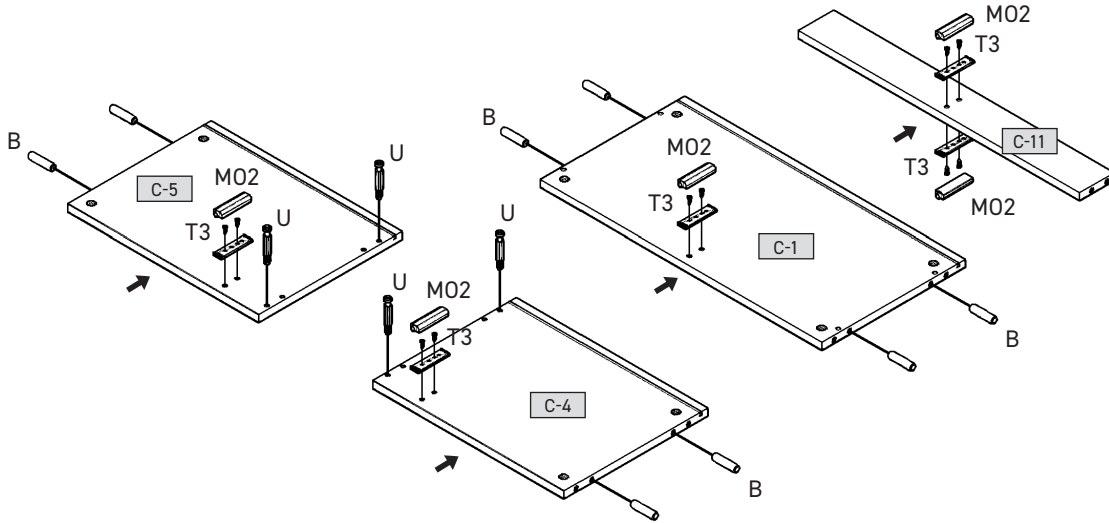

6

A x4 7x50mm	XA x1
-----------------------	--------------

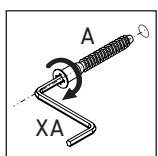
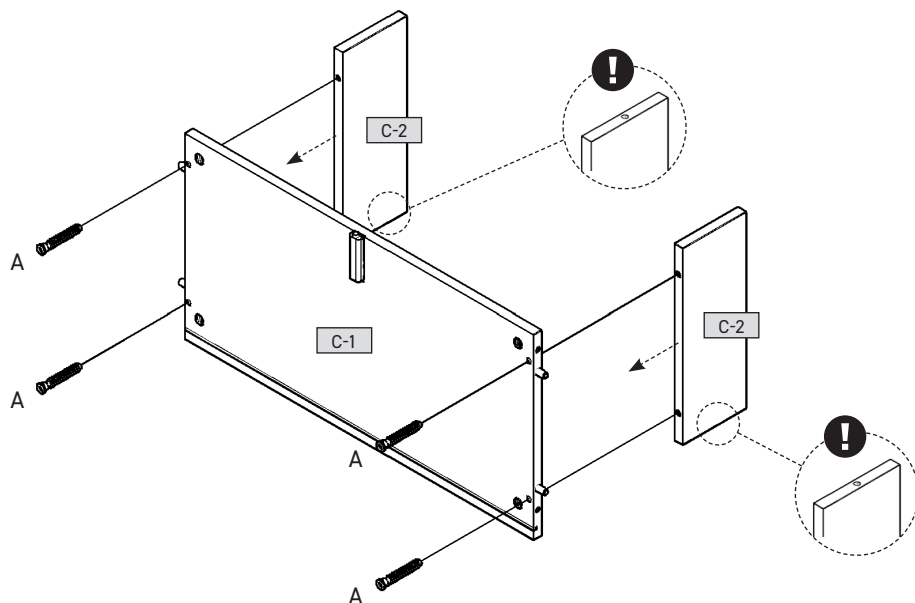

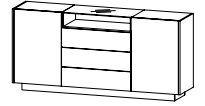

7



B	x8	K6	x3	T3	x12	U	x4
8x32mm		L=300mm		5x9mm		L=24,3mm	

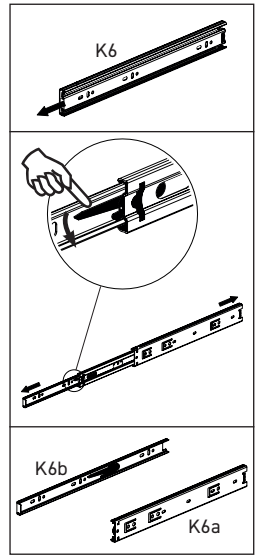
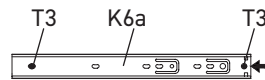
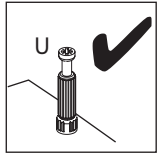
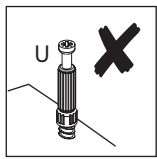
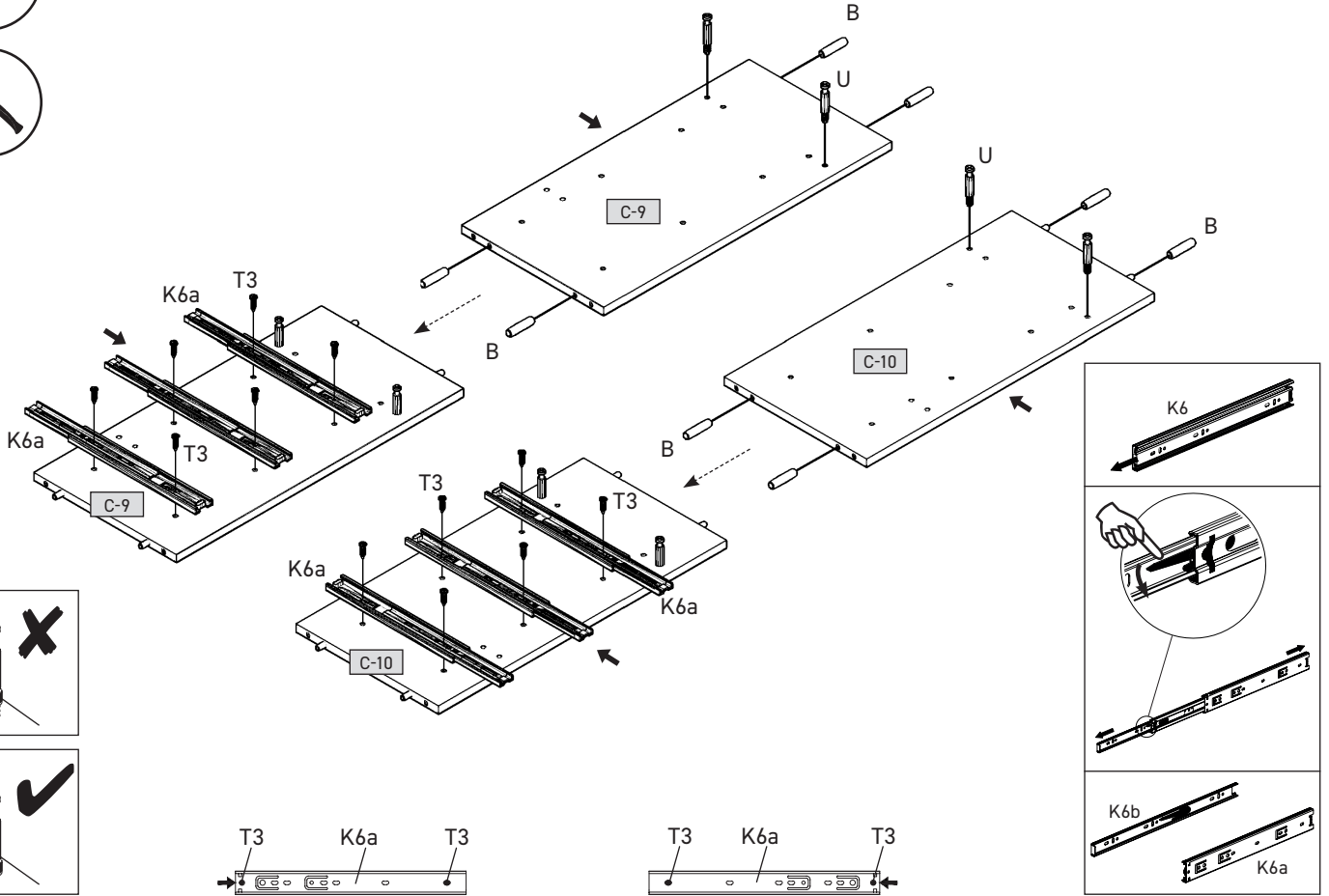

8



A	x4	R	x4	XA	x1
7x50mm		H=11mm			

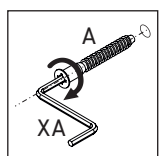
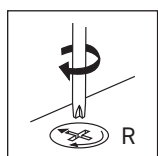
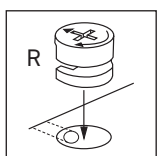
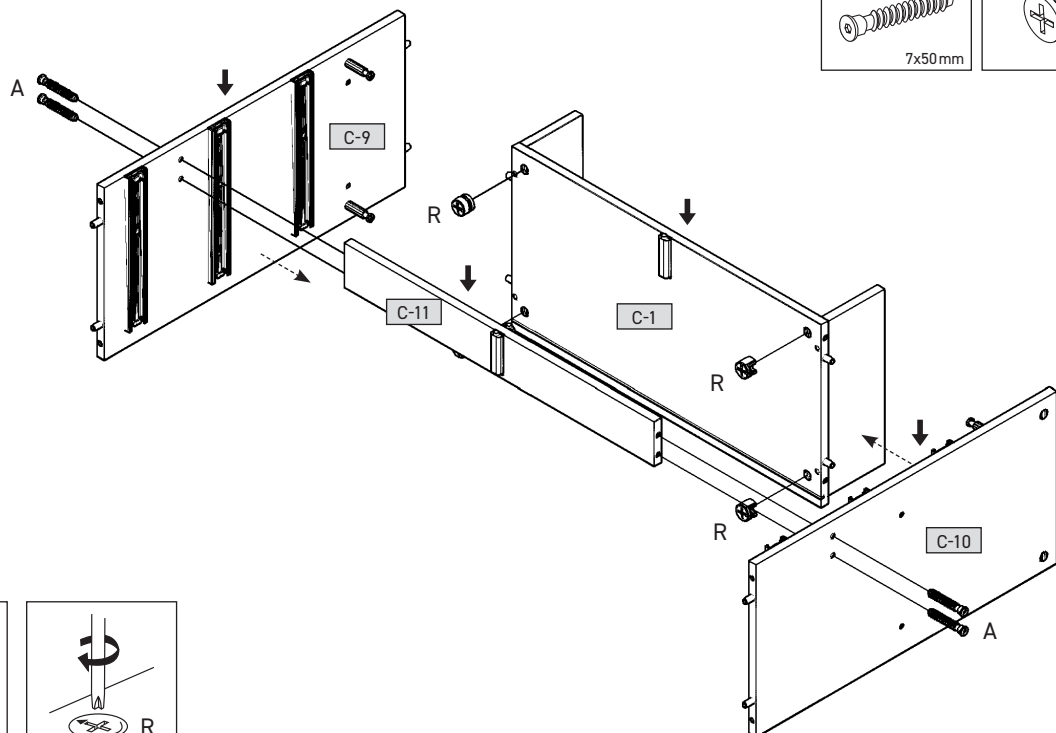

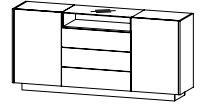

9

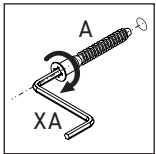
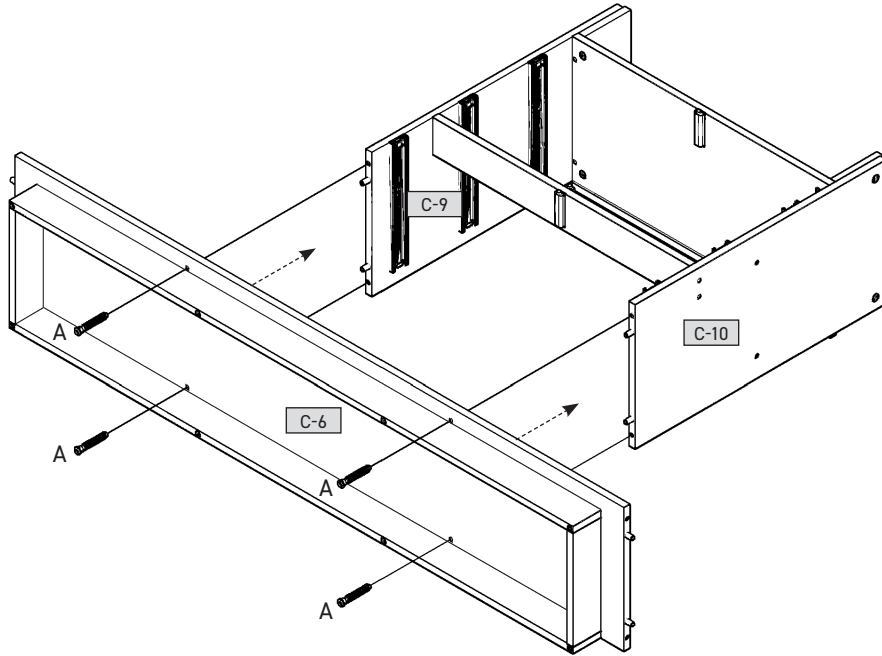
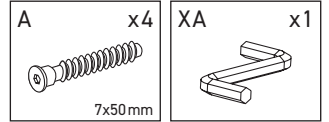

10

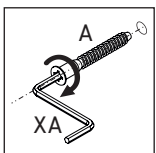
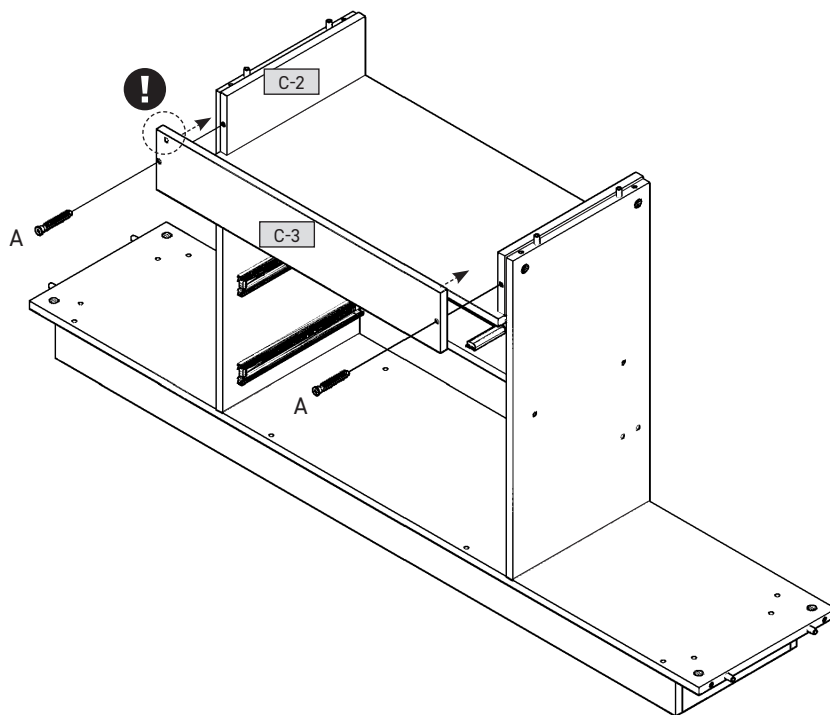
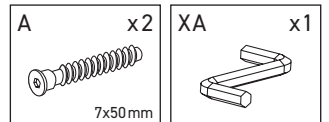

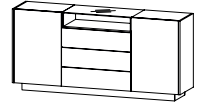

11

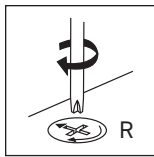
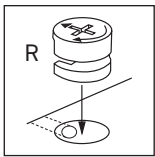
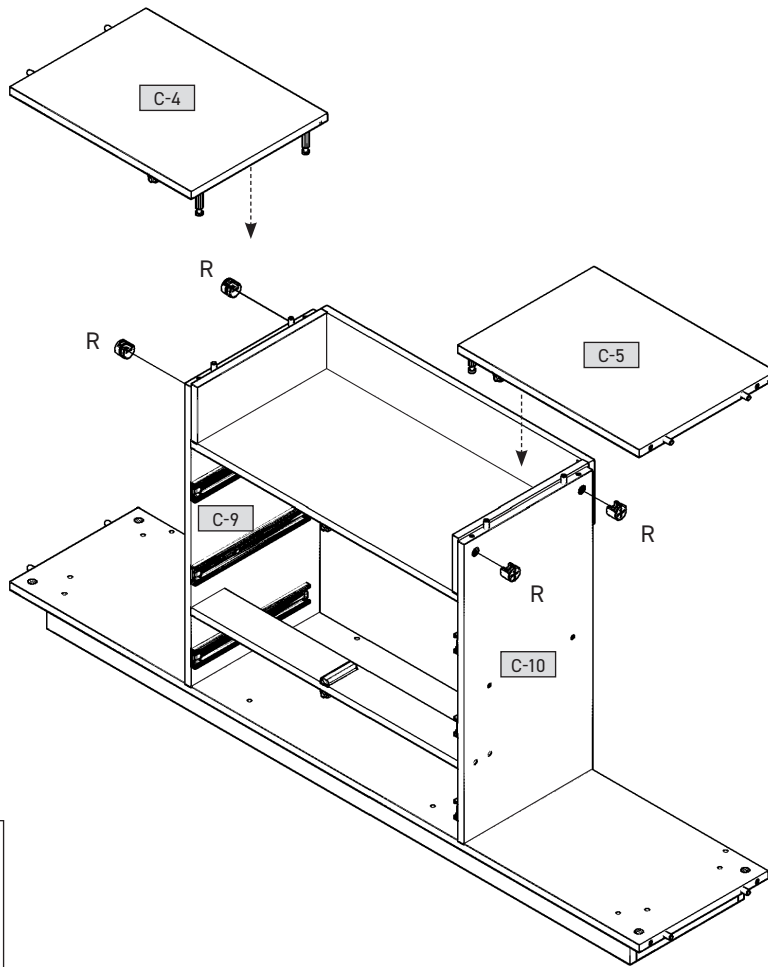
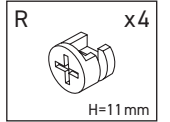

12

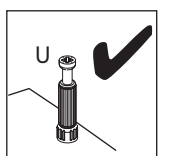
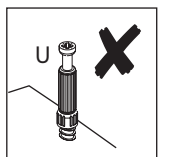
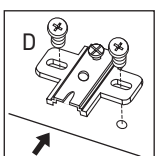
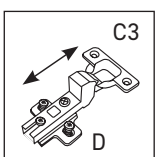
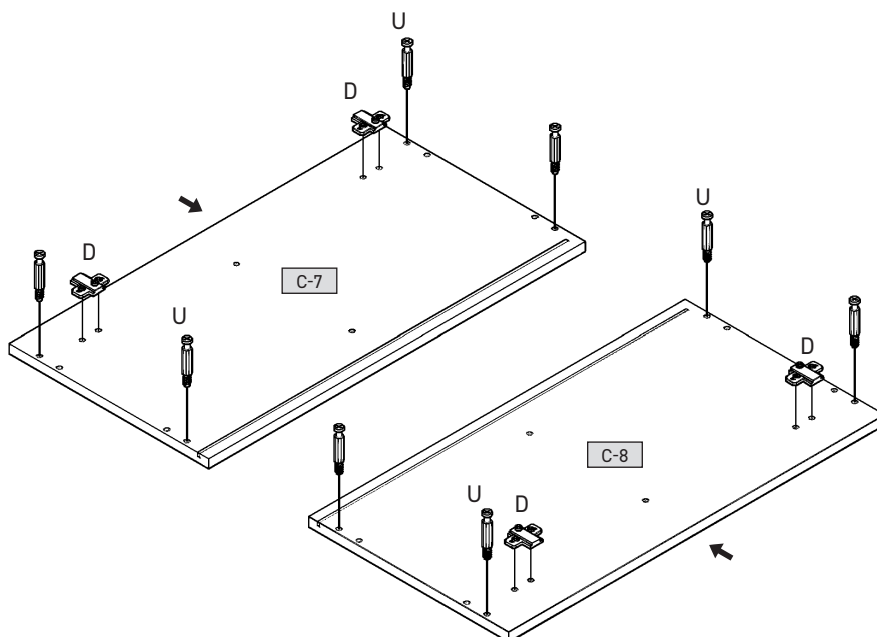
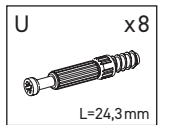
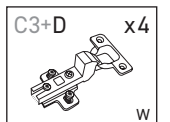

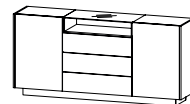

13

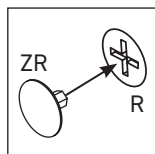
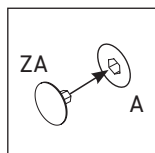
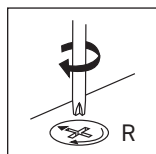
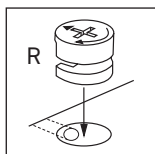
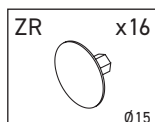
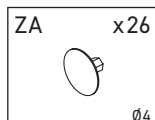
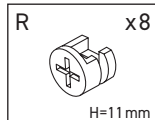
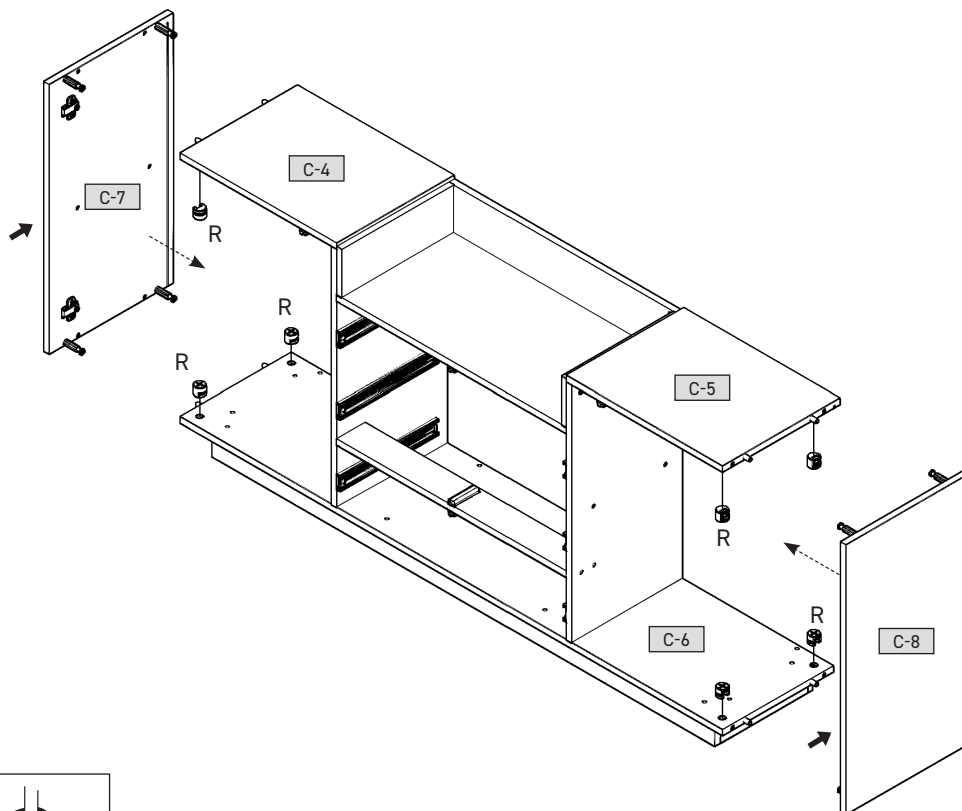

14

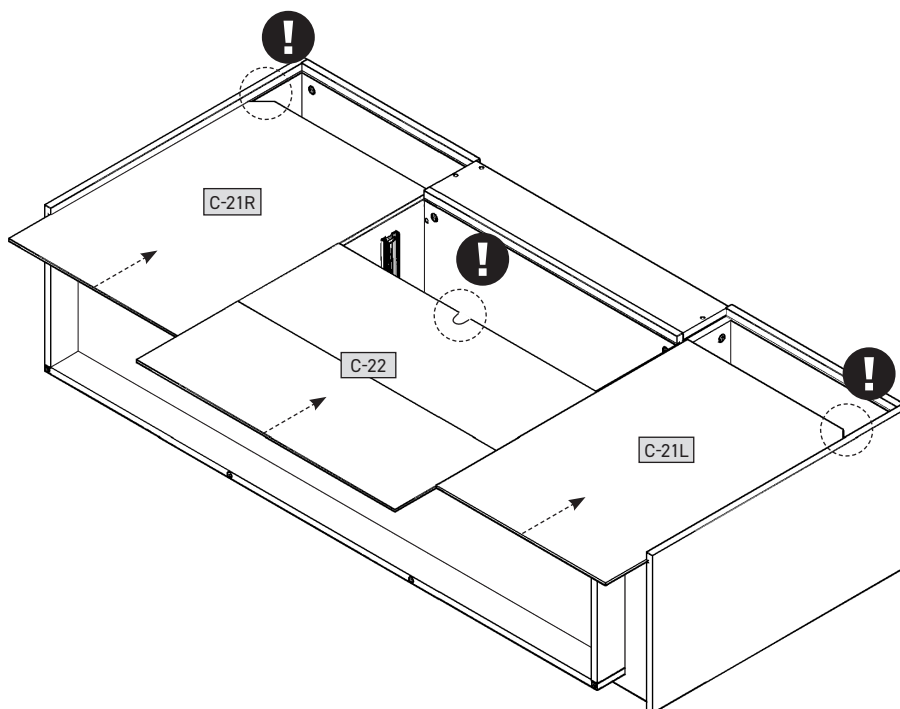

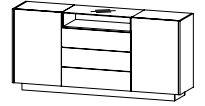

15

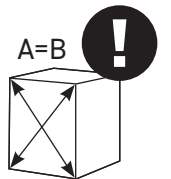
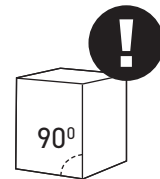
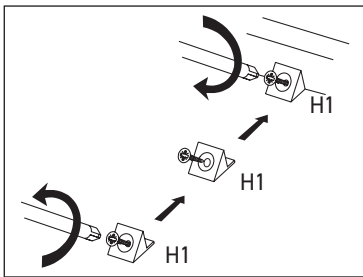
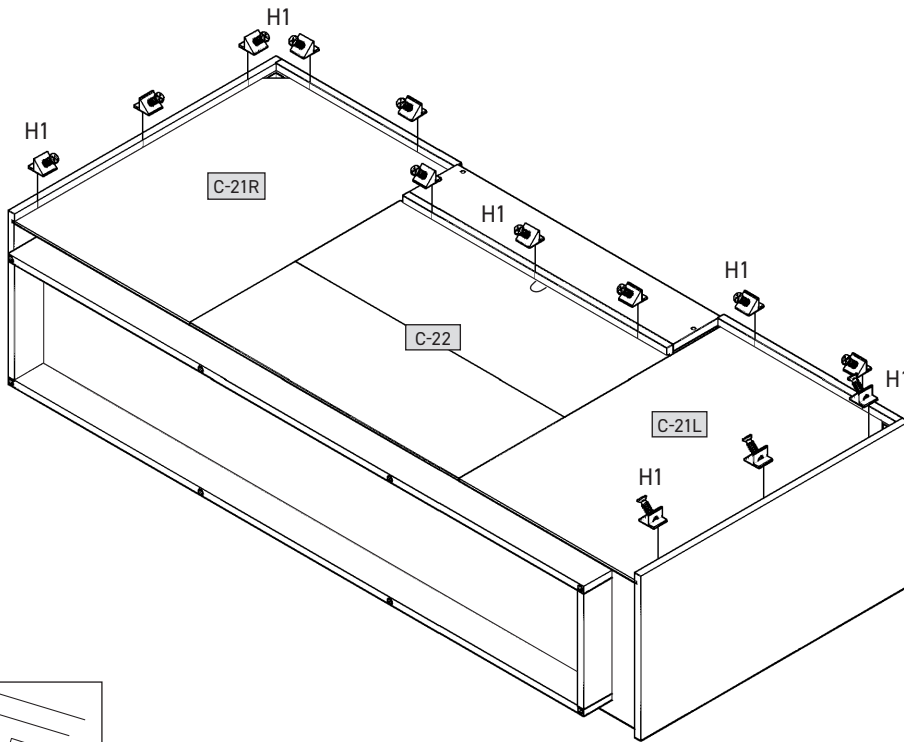
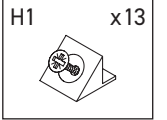

16

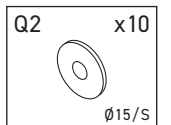
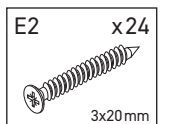
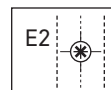
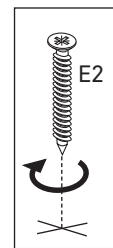
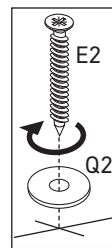
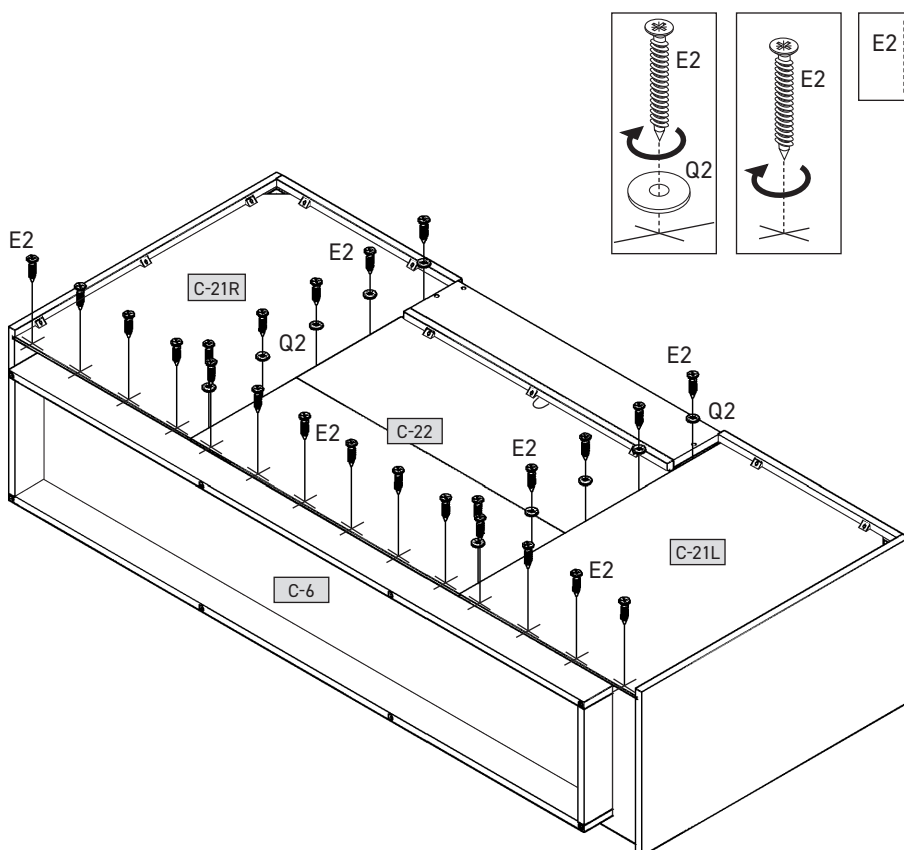

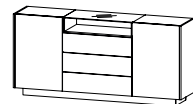

17

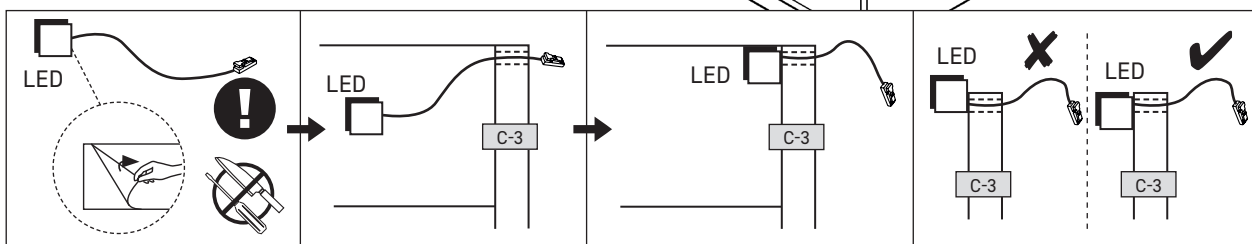
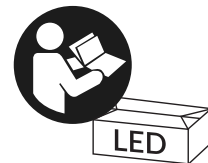
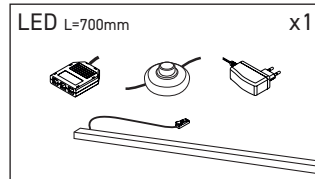
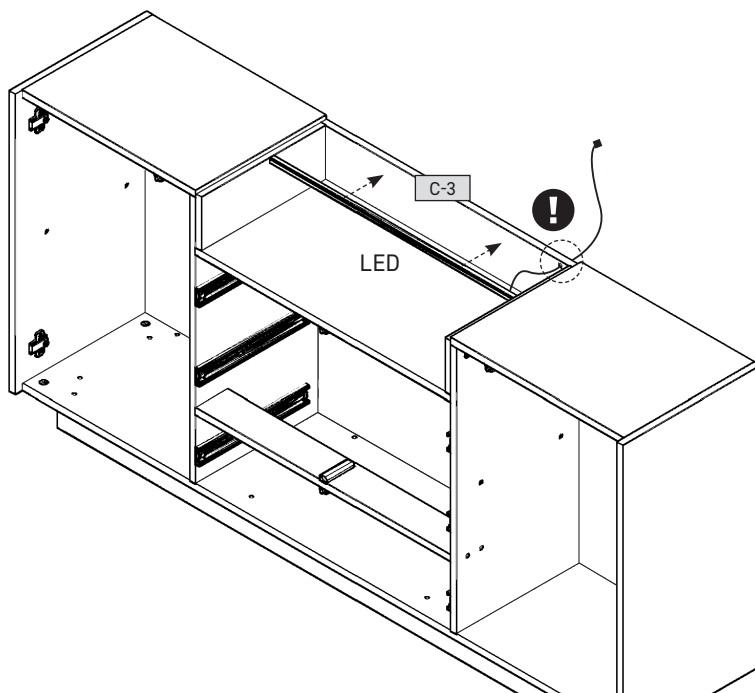

18

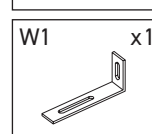
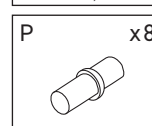
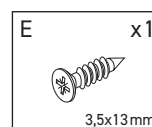
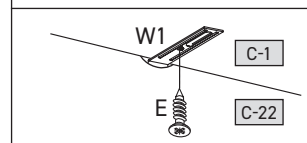
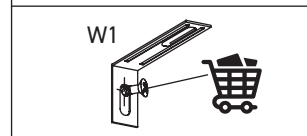
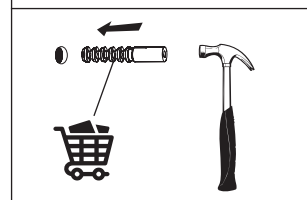
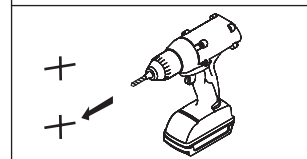
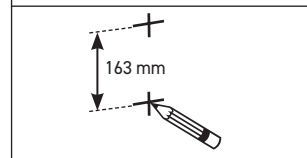
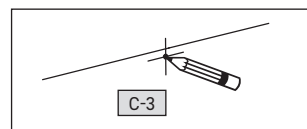
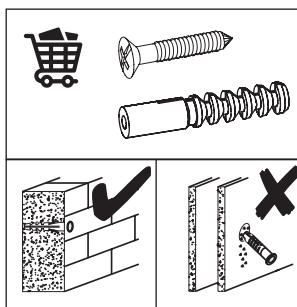
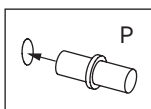
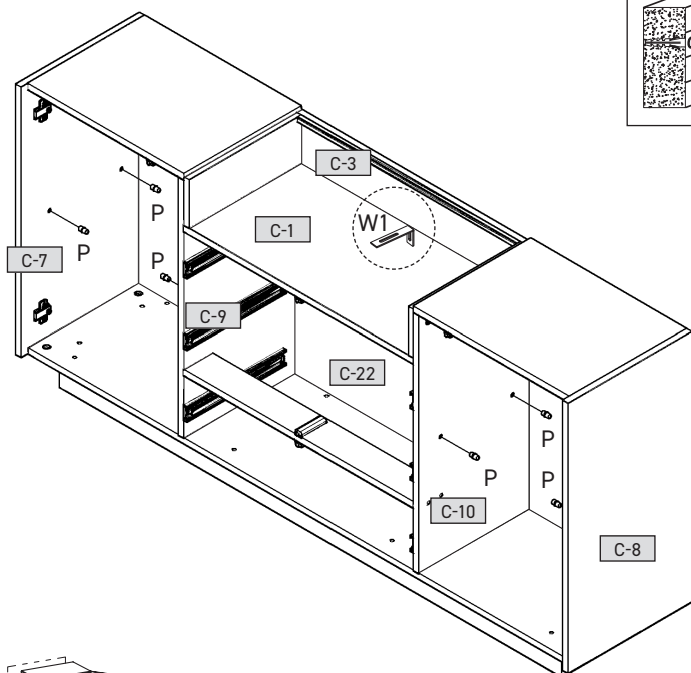
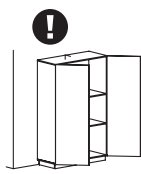
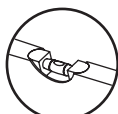

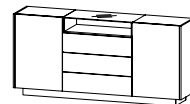

19

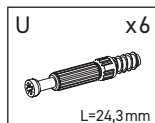
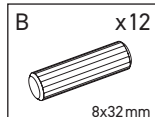
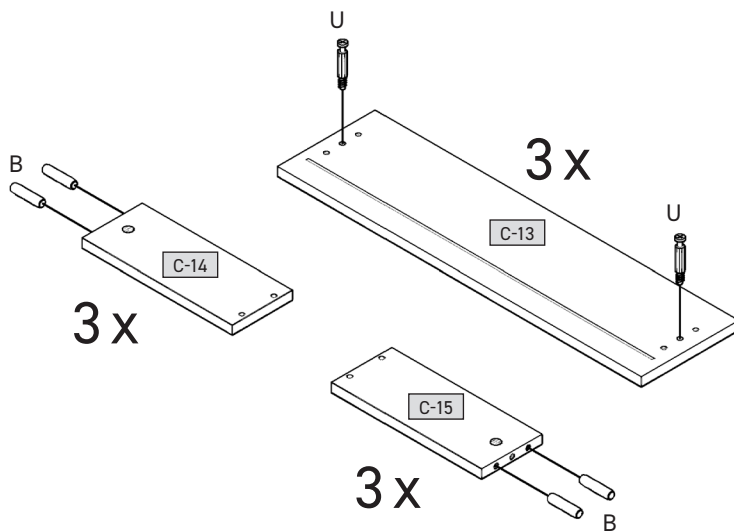
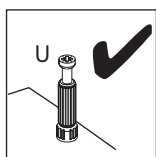
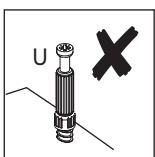

20

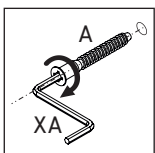
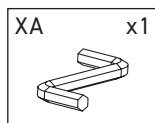
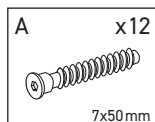
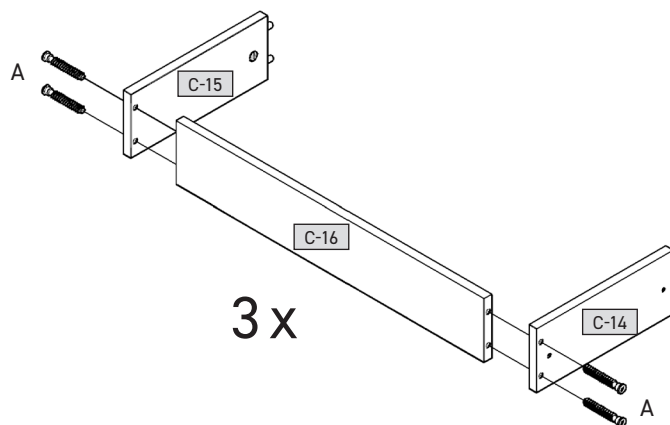

21

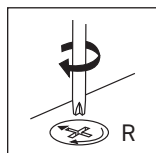
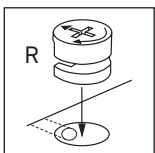
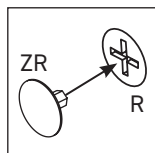
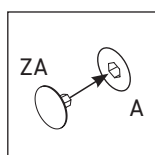
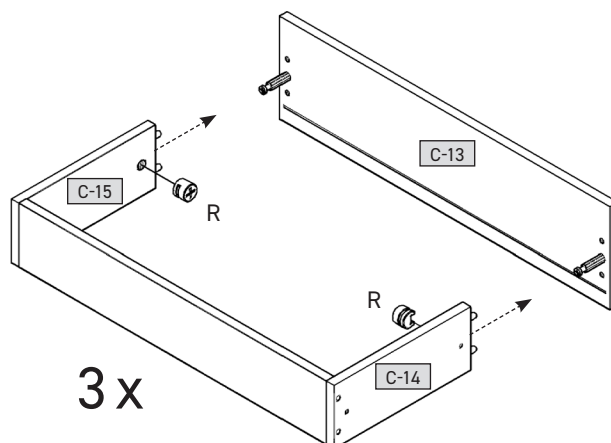
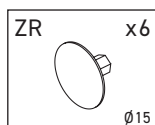
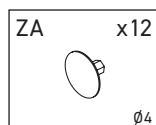
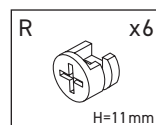

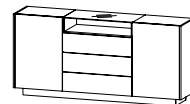

22

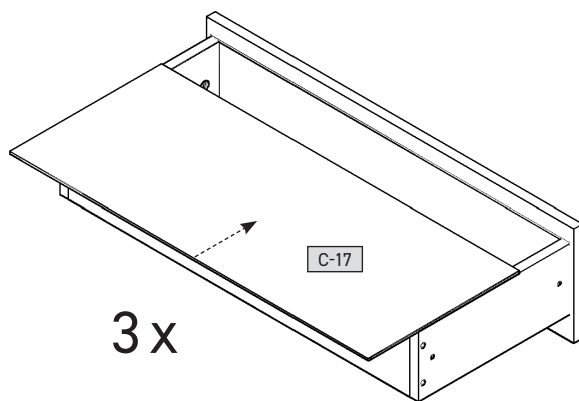

23

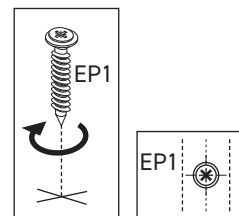
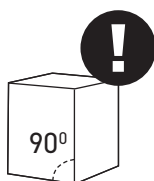
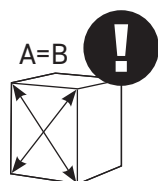
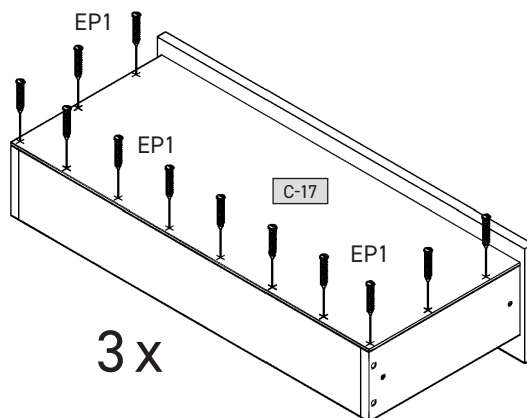
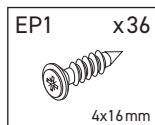

24

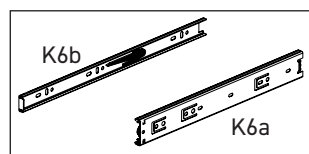
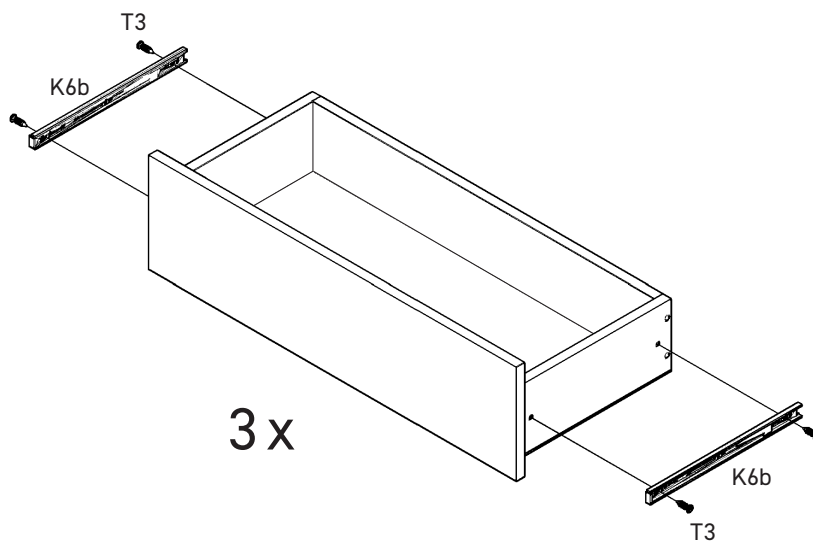
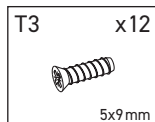
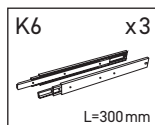

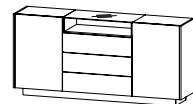

25

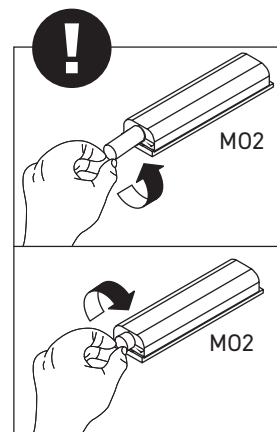
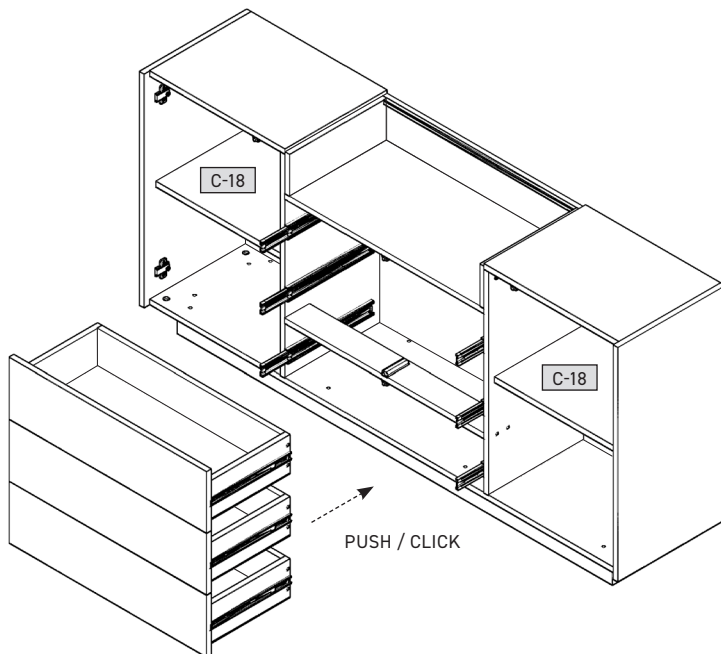

26

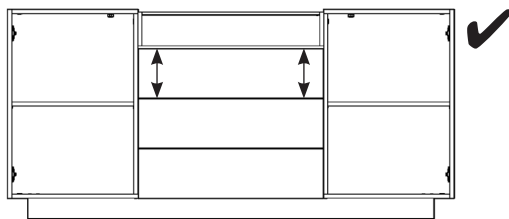
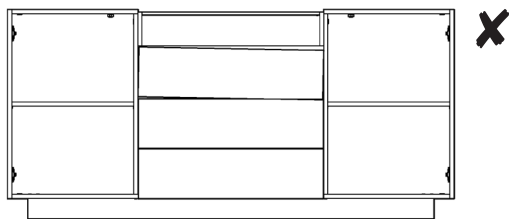

A

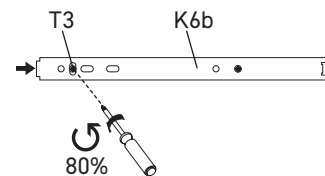
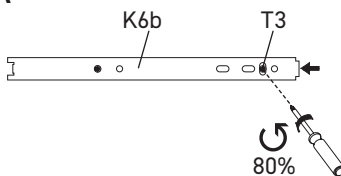

B

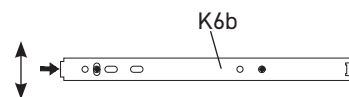
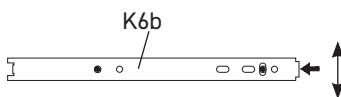

C

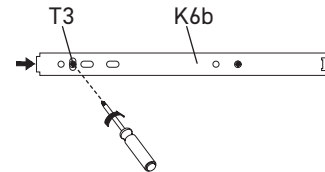
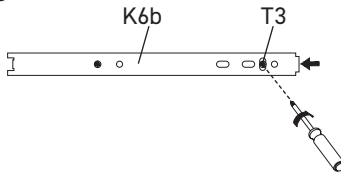

27

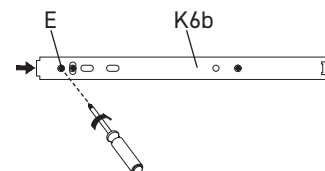
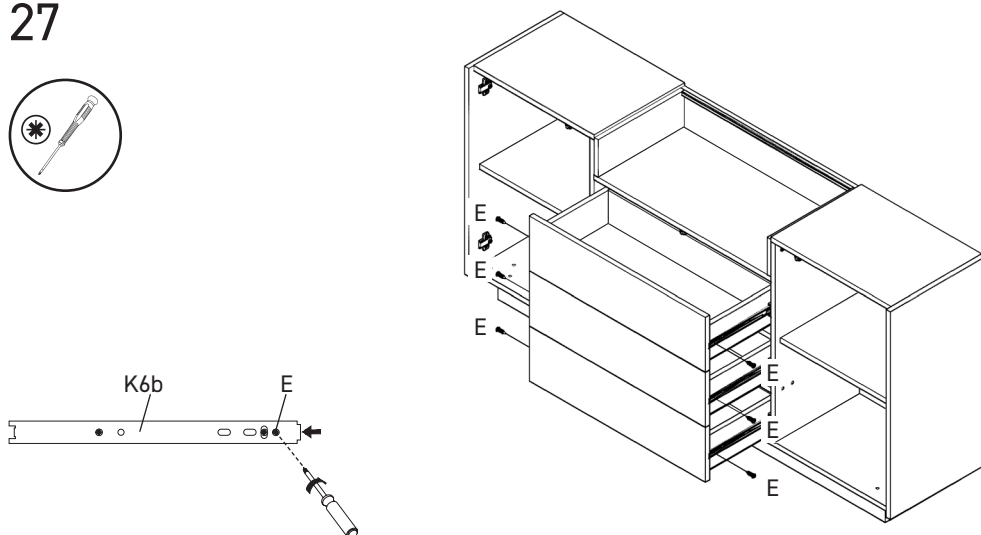
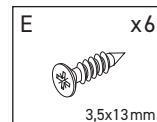

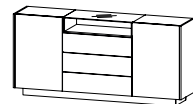

28

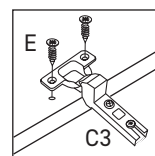
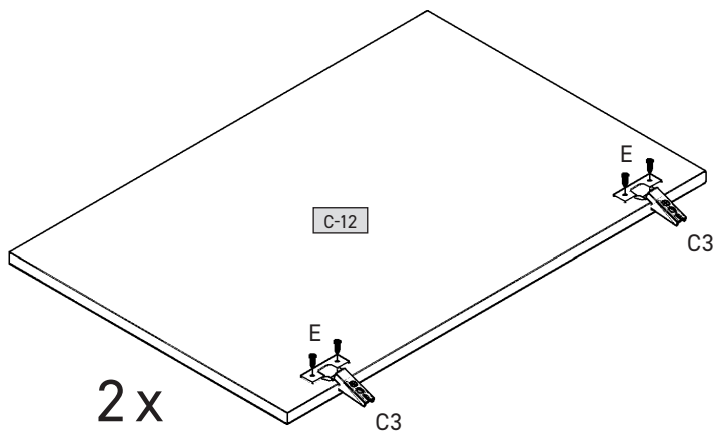
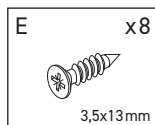
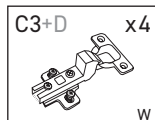

29

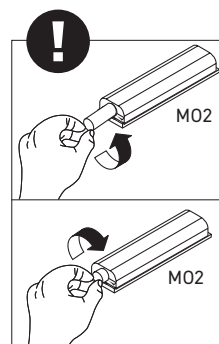
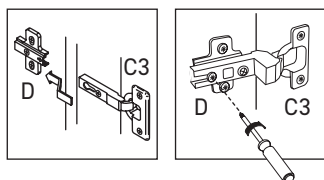
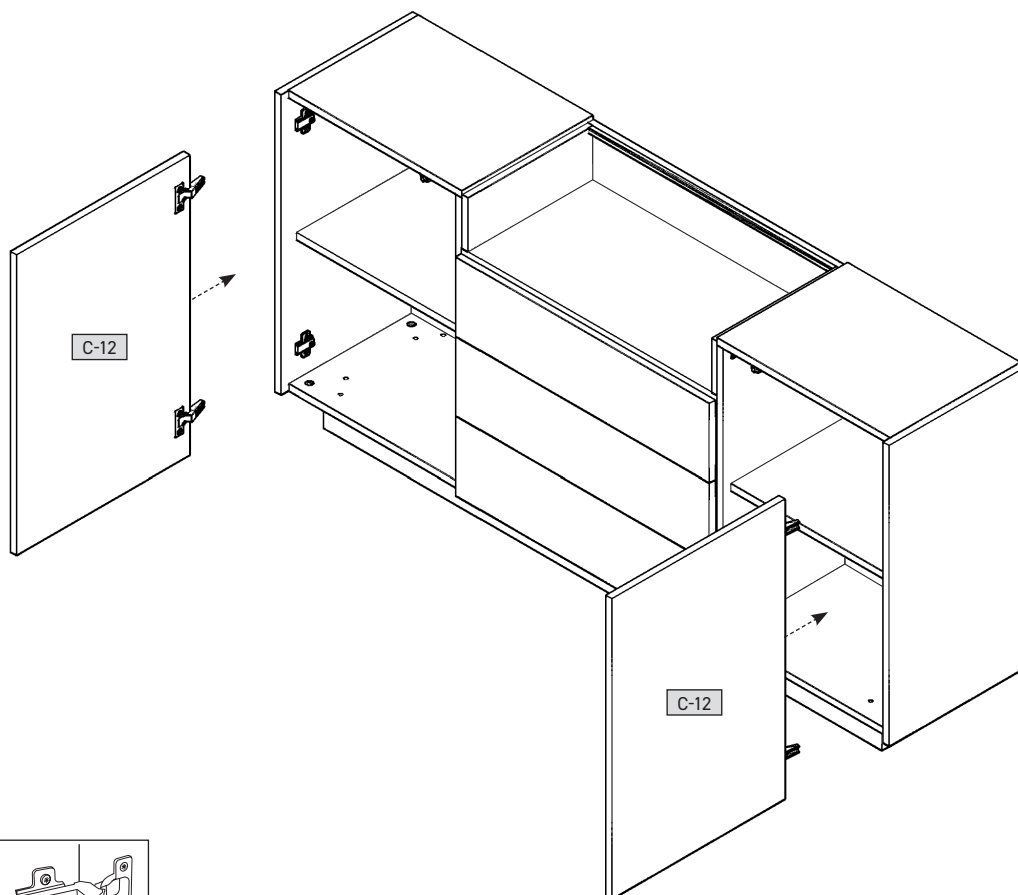

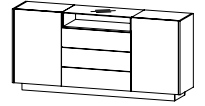

30

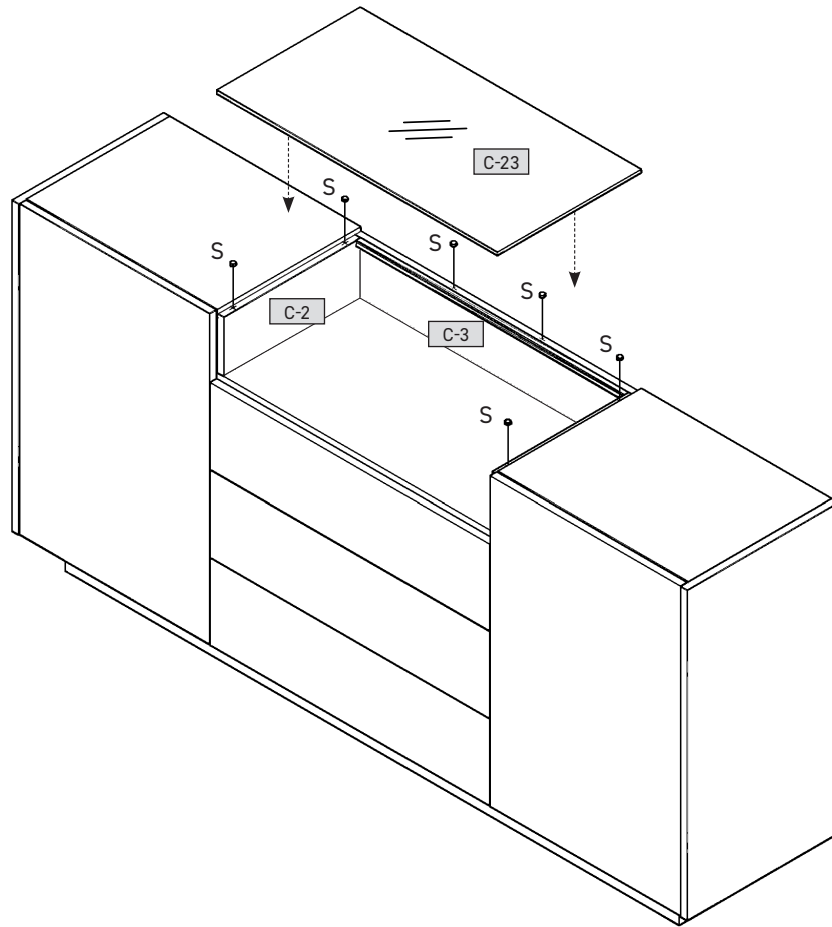
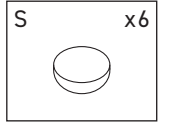

31

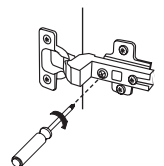
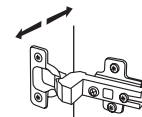
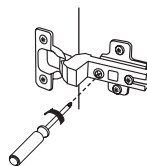
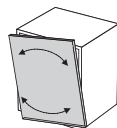
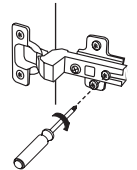
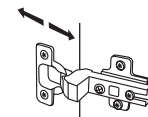
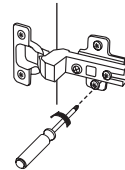
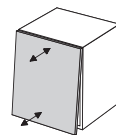
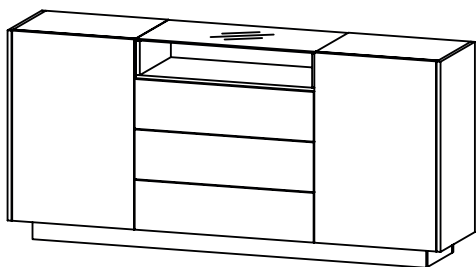
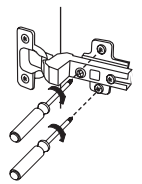
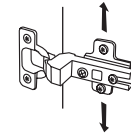
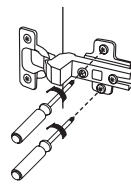
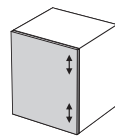

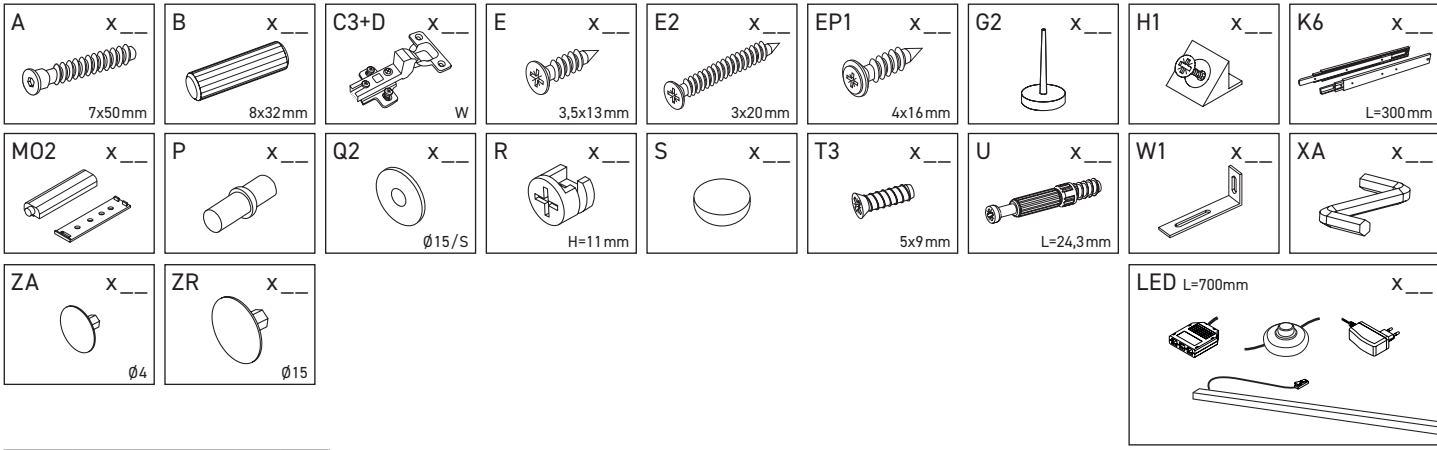

C-1	734	374	16	x 1	2/2
C-2	133	357	16	x 2	1/2
C-3	734	133	16	x 1	1/2
C-4	499	374	16	x 1	2/2
C-5	499	374	16	x 1	2/2
C-6	1732	353	16	x 1	1/2
C-7	746	395	16	x 1	2/2
C-8	746	395	16	x 1	2/2
C-9	714	353	16	x 1	1/2
C-10	714	353	16	x 1	1/2
C-11	734	90	16	x 1	2/2
C-12	496	746	16	x 2	2/2
C-13	728	195	16	x 3	1/2
C-14	300	120	16	x 3	1/2
C-15	300	120	16	x 3	1/2
C-16	678	120	16	x 2	1/2
C-16	678	120	16	x 1	2/2
C-17	708	306	3	x 3	1/2
C-18	483	330	16	x 2	1/2
C-19	1604	80	16	x 2	1/2
C-20	280	80	16	x 2	1/2
C-21L	736	499	3	x 1	2/2
C-21R	736	499	3	x 1	2/2
C-22	594	746	3	x 1	1/2
C-23	732	374	6	x 1	2/2

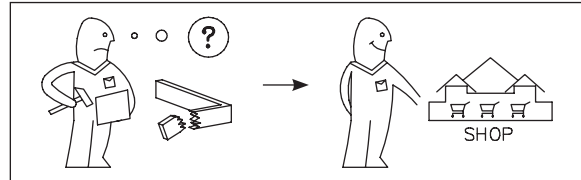
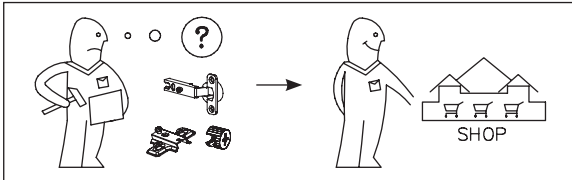
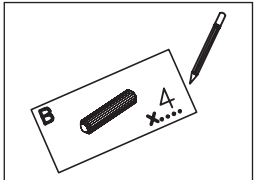
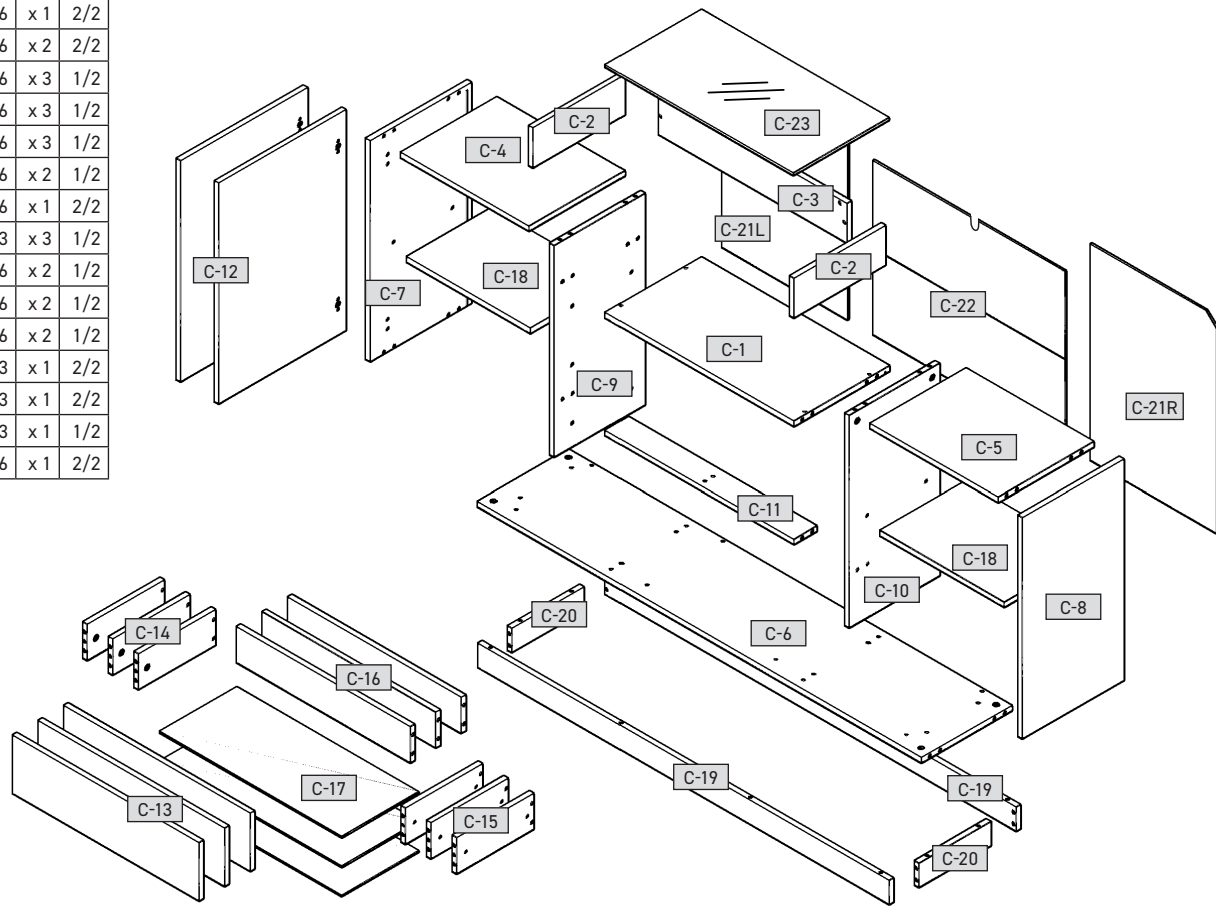

DE Möbel aus Naturholz und Plattenwerkstoffen

PL Mebel z drewna naturalnego oraz płyt drewnopochodnych

NL Meubelen van natuurhout en plaatmateriaal

GB Furniture made of natural wood and panel materials

IT Mobili in legno naturale e materiali pannellati

FR Meuble en bois naturel et plaque en dérivé du bois

PT Móveis feitos de madeira natural e tábuas semelhanhantes a madeira

DE	NL
-----------	-----------

Liebe Kundin,

lieber Kunde,

Wir dank Ihnen Bestellung!
Niezależnie od tego, czy zakupiemy przez Państwa mebel został wykonany z drewna litego, czy też posiada on front wykonany z płyty o wysokim szkleczym, lub też z płyty pokrytej malowym tworzywem sztucznym – każdy taki mebel na swoje specjalne właściwości. Rownież właściwości i struktura drewna – jak np. niewielkie słoje w naturalnym drewnie, które nadają mu jego indywidualnego charakteru. Rownież meble z drewna naturalnego są neustannie wystawione na działanie wilgoci i czynników atmosferycznych, mogą na ich powierzchnię sporadycznie pojawiać się zmiany, jak np. odbarwienia czy rysy. Z biegiem czasu może zmienić się nasycenie koloru i drewno może ściemnieć. Wskazujemy zmiany zachodzące w wyglądzie produktów w celu poinformowania Państwa o ich naturalnym. Niniejsza instrukcja zawiera cenę, aby jak najdłużej wskazówki dotyczące pielęgnacji mebli, aby jak najdłużej mogli Państwo cieszyć się z ich niezagannego wyglądu.

Podstawowe zasady:

- Nie stawiać na meblach gorących przedmiotów, nie wkładać na nie ciężkich przedmiotów
- W przypadku rozlania wody natychmiast ją wyczerć.
- Sprawdzać w regularnych odstępach czasu, czy szruby są dokręcone, a okucia dobrze przyczepione.
- Charakterystyczny, aromatyczny zapach drewna występujący w przypadku mebli wykonanych z drewna naturalnego jest oznaką wysokiej jakości produktu.
- Ważną rolę w pielęgnacji mebli z powodu występowania zwińcy – można je wygotować suchą.
- Kaïne Kerzen direkt auf die Möbel stellen.
- Verschnütete Flüssigkeiten sofort aufwischen.
- In regelmäßigen Abständen aufwischen.

festen Sitz von Schrauben und Beschlägen kontrollieren.

- Der typische, aromatische Holzgeruch des Naturholzmöbels immer ein Zeichen für Qualität.
- Helle Stellen an den Händen entstehen durch einen natürlichen Harzaustritt und können mit einem trockenen, fusselfreien Tuch abpoliert werden.
- Auch von anderen Holz-, Lack-, Leder- oder Polstermaterialien ist ein schwacher Eigengeruch am Anfang unvermeidbar. Diese Gerüche verschwinden mit der Zeit von allein. Wo Sie den mebeln helfen wollen, können Sie in der Anfangszeit häufiger und/oder wischen Sie die Möbel leicht feucht mit Wasser aus, das mit ein wenig Essig versetzt ist.
- Bewahren Sie diese Hinweise gut auf.

Pflegehinweise für Möbel aus Plattenwerkstoffen
Verwenden Sie zur Pflege Ihres Möbels aus Plattenwerkstoffen am besten ein weiches, sauberes, fusselfreies, nicht-alkoholisches Reinigungsmittel. Wischen Sie die Oberflächen leicht feucht ab.

Grundsätzlich gilt: Verwenden Sie bitte auf keinen Fall folgende Reinigungsund Pflegemittel:

- Microfasertücher oder Schmirzradierer.
- Diese enthalten häufig feine Schmirzpartikel, die zu einem Zerknäten des Möbels führen können.
- Scharfe chemische Substanzen sowie scheuernde Putz- oder Lösungsmittel. Diese können die Oberflächen ebenfalls beschädigen;
- Scheuerpulver, Stahlwolle oder Schleifmittel. Sie zerstören die Oberfläche so stark, dass eine Aufarbeitung nicht mehr möglich ist;
- Staubsauger, Bürsten und Bürstchen. Durch den hohen Druck und die Hitze, mit denen der Wasserdampf auf die Oberflächen trifft, können diese beschädigt werden oder sich sogar vom Untergrund ablösen.

Ihre Produktentwicklung

TR Doğal ahşap ve kereste malzemelerden Üretilmiş mobilyaer

RU Мебель из натурального дерева и древесных панелей.

RO Mobilă din lemn natural și materiale fibrolemnoase

CZ Nábytek z přírodního dřeva a deskových materiálů

SK Nábytok z prírodného dreva a drevovláknitých deskových materiálov

HU Bűtor természetes faanyagból és bútortápból

ES Muebles de madera natural y tableros símil madera

TR	RU
-----------	-----------

Beste klant,

Hierlijk dank voor uw bestelling!
Het meerk tint uit u, u een meubelstuk wordt geleverd.
Niezależnie od tego, czy zakupiemy przez Państwa mebel został wykonany z drewna litego, czy też posiada on front wykonany z płyty o wysokim szkleczym, lub też z płyty pokrytej malowym tworzywem sztucznym – każdy taki mebel na swoje specjalne egnosci. Rownież właściwości i struktura drewna – jak np. niewielkie słoje w naturalnym drewnie, które nadają mu jego indywidualnego charakteru. Rownież meble z drewna naturalnego są neustannie wystawione na działanie wilgoci i czynników atmosferycznych, mogą na ich powierzchnię sporadycznie pojawiać się zmiany, jak np. odbarwienia czy rysy. Z biegiem czasu może zmienić się nasycenie koloru i drewno może ściemnieć. Wskazujemy zmiany zachodzące w wyglądzie produktów w celu poinformowania Państwa o ich naturalnym. Niniejsza instrukcja zawiera cenę, aby jak najdłużej mogli Państwo cieszyć się z ich niezagannego wyglądu.

De genoemde wijzigingen vormen bij een natuurlijke grondstof zoals hout een normaal proces.
Dzięki tej zmianie, jak np. niewielkie słoje w naturalnym drewnie, które nadają mu jego indywidualnego charakteru. Rownież meble z drewna naturalnego są neustannie wystawione na działanie wilgoci i czynników atmosferycznych, mogą na ich powierzchnię sporadycznie pojawiać się zmiany, jak np. odbarwienia czy rysy. Z biegiem czasu może zmienić się nasycenie koloru i drewno może ściemnieć. Wskazujemy zmiany zachodzące w wyglądzie produktów w celu poinformowania Państwa o ich naturalnym. Niniejsza instrukcja zawiera cenę, aby jak najdłużej mogli Państwo cieszyć się z ich niezagannego wyglądu.

In principe geldt:
• Plaats geen hete voorwerpen op de meubelen.

- Voeg gemorstte vloeistoffen direct af.
- Controleer met regelmatige intervallen de beslag op houtvast van schroeven en bouten.
- De typische, aromatische houtgeur is steeds een kwaliteitsbewijs bij natuurhouten meubelen.
- Heldere plaatsen aan de takken ontstaan door een natuurlijk uitdrennen van hars en kunnen worden weggepoijst met een droge, pluisjevrije doek.
- Ook van andere houten, gelakte, lederen of polstermaterialen is een zwakke eigen reuk bij het begin niet te vermijden. Deze geuren verdwijnen na enige tijd vanzelf. Als u wilt dat het sneller gaat, verlucht u in het begin vaker en/of veegt de meubelen lichtjes vochtig af met water, dat een beetje is aangelegend met azijn.
- Bewaar deze instructies goed.

Onderbouwstructuur voor meubelen
Gebruik voor de reiniging van uw meubel van plaatmateriaal het best een zachte, niet pluisdige doek of een leren doek. Veeg de oppervlakten leraat vochtig af.

In principe geldt: Gebruik zeker niet volgende reinigings- en poetsmiddelen:
• microvezeldoeken of vuilgommelen. Deze bevatten vaak fijne spindelvezels die kunnen leiden tot wassen op de oppervlakten.
• scherpe chemische substanties zoals oplosmiddelen. Deze kunnen de oppervlakken eveneens beschadigen;
• schuurpoeder, staalwol of pampensponzen. Ze vernietten het oppervlak zo erg dat een reparatie niet meer mogelijk is;
• stofzuiger. Mondstukken en borstels kunnen beschadigen op de oppervlakten;
• vaatwasser. Door de hoge druk en de hitte, waarmee de stoom op de bovenlagen komt, kunnen deze worden beschadigd of zelfs loskomen van de ondergrond.

Dear customer,

Thank you for your order!
No matter if you bought a piece of furniture made from natural wood, a high-gloss front or a plastic front – every piece of furniture has unique characteristics. Even the texture and structure of wood, such as small knots in natural wood furniture, are part of the individual charms of each piece of furniture.

Since natural wood furniture are permanently exposed to climate and humidity fluctuations, changes to the surface may occur (e.g. hair cracks or changes in colour) in some cases. In general, brightness decreases and colour saturation increases in the course of time – the wood darkens. The changes mentioned above are normal for natural raw materials such as wood. This booklet provides some care tips for your piece of furniture so that you can enjoy it for a long time.

The following applies in general:
• Don't place any hot objects on the furniture.
• Don't place candles directly on the furniture.
• Immediately wipe off any spilled liquids.
• Regularly check if the screws and fittings are tight.

- The typical, aromatic wooden odour is always a proof of quality for natural wood furniture.
- The natural emission of resin may produce bright spots on the knots which can be polished with a dry, lintfree cloth.

• Initially, a slight intrinsic odour is unavoidable for other wooden, paint, leather or upholstery materials too. These odours automatically disappear after a while. If you want to speed up this process, ventilate more often at the beginning and/or wipe out the furniture with a slightly damp cloth which was soaked in water mixed with a small amount of vinegar.
• Keep these notes in a safe place.

Care notes for furniture made of panel materials
We recommend using a soft, lint-free cloth or a shammy for conditioning your piece of furniture made of panel materials. Wipe off the surfaces with a slightly damp cloth or shammy.
The following applies in general:
Please don't use the following detergents or cleaning agents at all:
• microfibre cloths or dirt erasers. They often contain fine abrasive particles which can cause scratches on the surfaces;
• aggressive chemical substances as well as abrasive cleaning agents or solvents. They may damage the surface;
• scouring powder, steel wool or scouring pads. They destroy the surface so badly that reconditioning is impossible;
• vacuum cleaners. The nozzles and brushes can cause scratches on the surfaces;
• steam cleaners. The surfaces may be damaged or separated from the ground due to the high pressure and heat of the water vapour.

Your product development team

IT

Genitori clienti,

sentiti ringraziamenti per il vostro ordine!
A prescindere che abbiate scelto un mobile realizzato in legno naturale, un fronte lucido o un fronte di materiale plastico opaco – ogni esemplare ha sue particolarità. Anche le caratteristiche e la struttura del legno, quali ad esempio rami minori nei mobili di legno naturale, sono parte del fascino individuale di ogni singolo mobile.

Dato che i mobili in legno naturale sono esposti al continuo variare del clima e dell'umidità, è probabile che in superficie insorgano mutamenti quali crepe capillari o cambiamenti di colore. Generalmente con passar del tempo, diminuisce la chiarezza e aumenta la saturazione del colore – il legno si scurisce. I citati mutamenti sono un normale processo dei materiali naturali, quali appunto il legno.

Il presente libretto intende darvi alcuni suggerimenti sulla cura del vostro mobile, affinché vi procuri lunghe soddisfazioni.

Sostanzialmente vale:

- Non poggiare oggetti roventi sui mobili dei mobili.
- Non poggiare candele a diretto contatto dei mobili.
- Asciugare subito i liquidi sversati.
- Ad intervalli periodici controllare se viti e cerniere sono salde.
- Il caratteristico odore fragrante è sempre una prova di qualità dei mobili in legno naturale.

• Le macchie chiare sui rami si formano per via della naturale fuoriuscita di resina, e sono levigabili con un panno asciutto che non lascia peli.
• Anche trattandosi di altri materiali lignei, di vernice, pelle o imbottiti, all'inizio è inevitabile un leggero odore caratteristico. Dopo qualche tempo però, questi odori svaniscono da sé. Potete aiutare a farli volatilizzare in minor tempo cambiando più spesso aria all'inizio e/o passando sui mobili un panno umido d'acqua con qualche goccia d'aceto.
• Conservare bene le presenti istruzioni.

Istruzioni sulla cura dei mobili in materiali pannellati
Per la cura dei mobili in materiali pannellati si consiglia di usare un panno morbido, che non lascia peli, o un panno di pelle. Passare il panno leggermente umido sulle superfici.

Sostanzialmente vale: In nessun caso utilizzare i seguenti detergenti e prodotti per la pulizia:
• panni in microfibra o spugna a tampono. Questi prodotti contengono spesso fini particelle abrasive, che possono provocare sgraffiature sui mobili;
• forti sostanze chimiche nonché detersivi o solventi abrasivi. Anche questi prodotti possono aggredire le superfici.

• polvere abrasiva, paglietta d'acciaio o spugna abrasiva. Rovineranno la superficie in modo tale che non sarebbe più possibile riparare;

- aspirapolvere. Bocchette e spazzole possono sgraffiare le superfici;
- pulitrice a vapore. Per via dell'elevata pressione e calore con cui il vapore colpisce le superfici, esse rischiano di deteriorarsi o addirittura staccarsi dalla sottostruttura.

Area Sviluppo prodotti

FR

Cher client,
merci pour votre commande !
Peu importe que vous ayez acheté un meuble fabriqué en bois naturel, un haut brillance ou une face en plastique mat – chaque meuble a ses propriétés spécifiques. Même les propriétés et la structure du bois, comme par exemple les petits nœuds sur des meubles en bois naturel, font partie de l'aspect de chaque meuble.

Comme les variations de bois naturel est soumis aux changements permanents du climat et de l'humidité, il se peut que quelques modifications surviennent sur la surface, comme par exemple de fines fissures ou des décorations. En règle générale, au cours du temps, la clarté du meuble diminue et la saturation des couleurs augmente. Les modifications susnommées sont un processus normal des matières naturelles de bois.

Ce petit livret vous donne quelques astuces sur l'entretien de votre meuble pour que vous puissiez en profiter longtemps.

En règle générale :
• Ne pas poser d'objets chauds sur le meuble.
• Ne pas poser de bougies directement sur le meuble.
• Essayer immédiatement les liquides renversés.

• A intervalles réguliers, contrôler que les vis et les ferrures sont bien en place.
• L'odeur aromatique typique du bois est toujours une preuve de qualité des meubles en bois naturel.
• Les endroits clairs sur les nœuds se produisent par une sécrétion naturelle de résine qui s'élimine avec un chiffon sec non pelucheux.
• Les autres matériaux, comme le bois, la peau, le cuir ou le textile, peuvent se dégrader inévitablement une légère odeur. Ces odeurs disparaissent d'elles-mêmes avec le temps. Si vous souhaitez qu'elles disparaissent plus vite, au début, aérez plus souvent et essayez les meubles avec un chiffon légèrement imbibé d'eau mélangée avec un peu de vinaigre.

Conservez bien cette notice.
Consignes de soin pour les meubles avec des plaques en dérivé du bois
Pour l'entretien de votre meuble en plaques en dérivé du bois, utilisez de préférence un chiffon doux non pelucheux à l'eau pure de chamois. Essayez la laine.

En règle générale :
• Ne pas poser d'objets chauds sur le meuble.
• Ne pas poser de bougies directement sur le meuble.
• Essayer immédiatement les liquides renversés.

• A intervalles réguliers, contrôler que les vis et les ferrures sont bien en place.
• L'odeur aromatique typique du bois est toujours une preuve de qualité des meubles en bois naturel.
• Les endroits clairs sur les nœuds se produisent par une sécrétion naturelle de résine qui s'élimine avec un chiffon sec non pelucheux.
• Les autres matériaux, comme le bois, la peau, le cuir ou le textile, peuvent se dégrader inévitablement une légère odeur. Ces odeurs disparaissent d'elles-mêmes avec le temps. Si vous souhaitez qu'elles disparaissent plus vite, au début, aérez plus souvent et essayez les meubles avec un chiffon légèrement imbibé d'eau mélangée avec un peu de vinaigre.

Conservez bien cette notice.
Consignes de soin pour les meubles avec des plaques en dérivé du bois
Pour l'entretien de votre meuble en plaques en dérivé du bois, utilisez de préférence un chiffon doux non pelucheux à l'eau pure de chamois. Essayez la laine.

En règle générale :
• Ne pas poser d'objets chauds sur le meuble.
• Ne pas poser de bougies directement sur le meuble.
• Essayer immédiatement les liquides renversés.

• A intervalles réguliers, contrôler que les vis et les ferrures sont bien en place.
• L'odeur aromatique typique du bois est toujours une preuve de qualité des meubles en bois naturel.
• Les endroits clairs sur les nœuds se produisent par une sécrétion naturelle de résine qui s'élimine avec un chiffon sec non pelucheux.
• Les autres matériaux, comme le bois, la peau, le cuir ou le textile, peuvent se dégrader inévitablement une légère odeur. Ces odeurs disparaissent d'elles-mêmes avec le temps. Si vous souhaitez qu'elles disparaissent plus vite, au début, aérez plus souvent et essayez les meubles avec un chiffon légèrement imbibé d'eau mélangée avec un peu de vinaigre.

Voire service de développement de produits



Uwaga - Upozornění - Achtung - Attention - Caution - Figyelem
 Attenzione - Opgelet - Atenție - Upozornenie - Dikkat

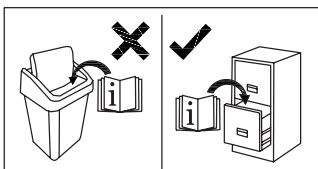
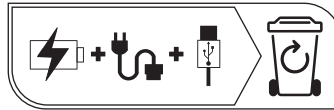
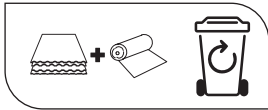
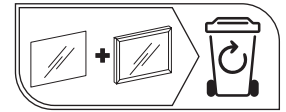
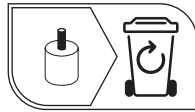
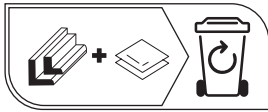
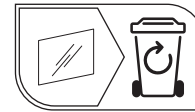
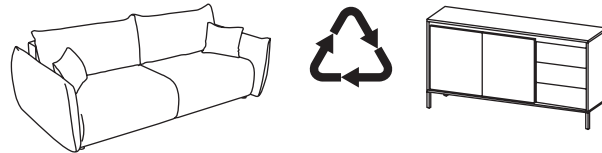
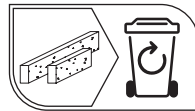
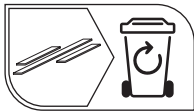
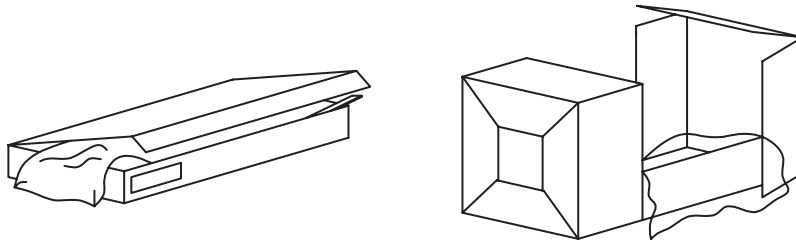

Producent - Produzent - Üretici - Producteur - Výrobce -
 Termelő - Produser - Produttore - Producător - Productor

MEBLE LASKI KACZOROWSKA SP.K.

Laski, ul. Kępińska 21, 63-620 Trzcinica
 meble-laski@meble-laski.com.pl



Uwaga - Upozornění - Achtung - Attention - Caution - Figyelem
 Attenzione - Opgelet - Atenție - Upozornenie - Dikkat

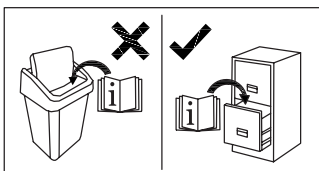
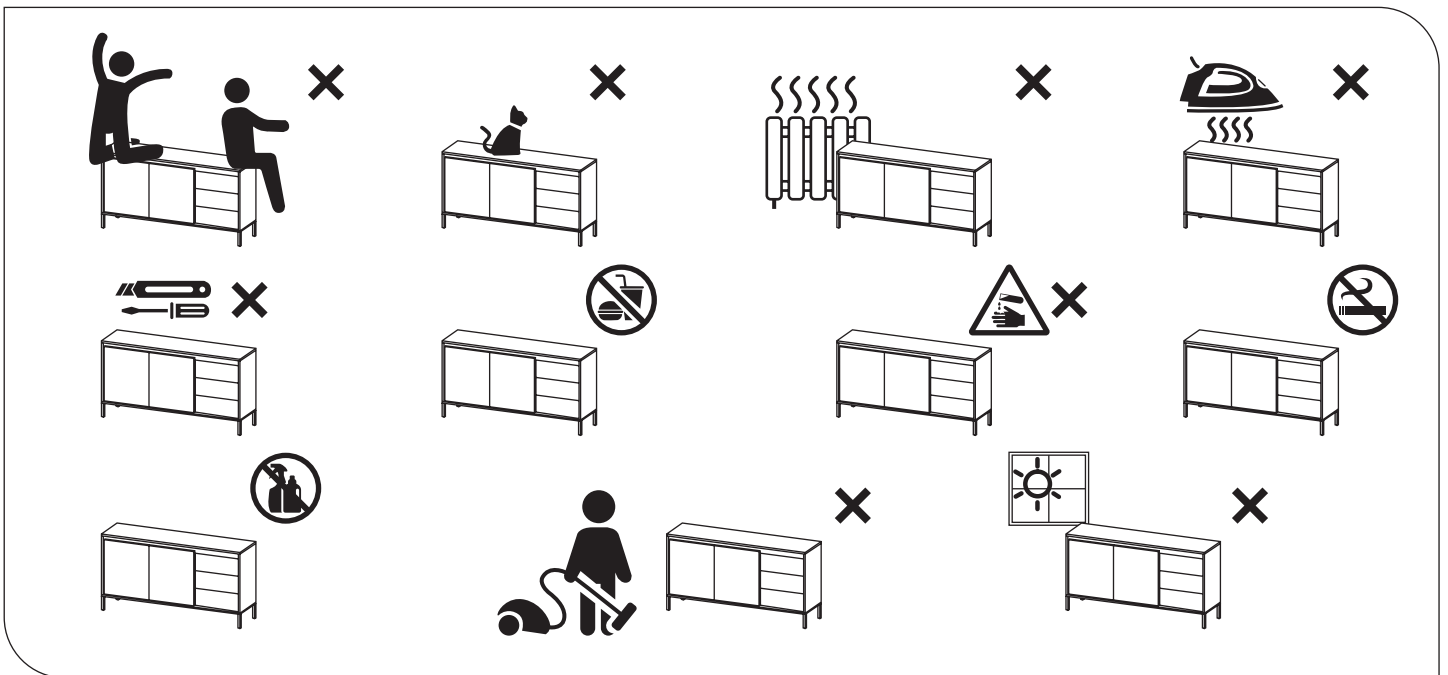
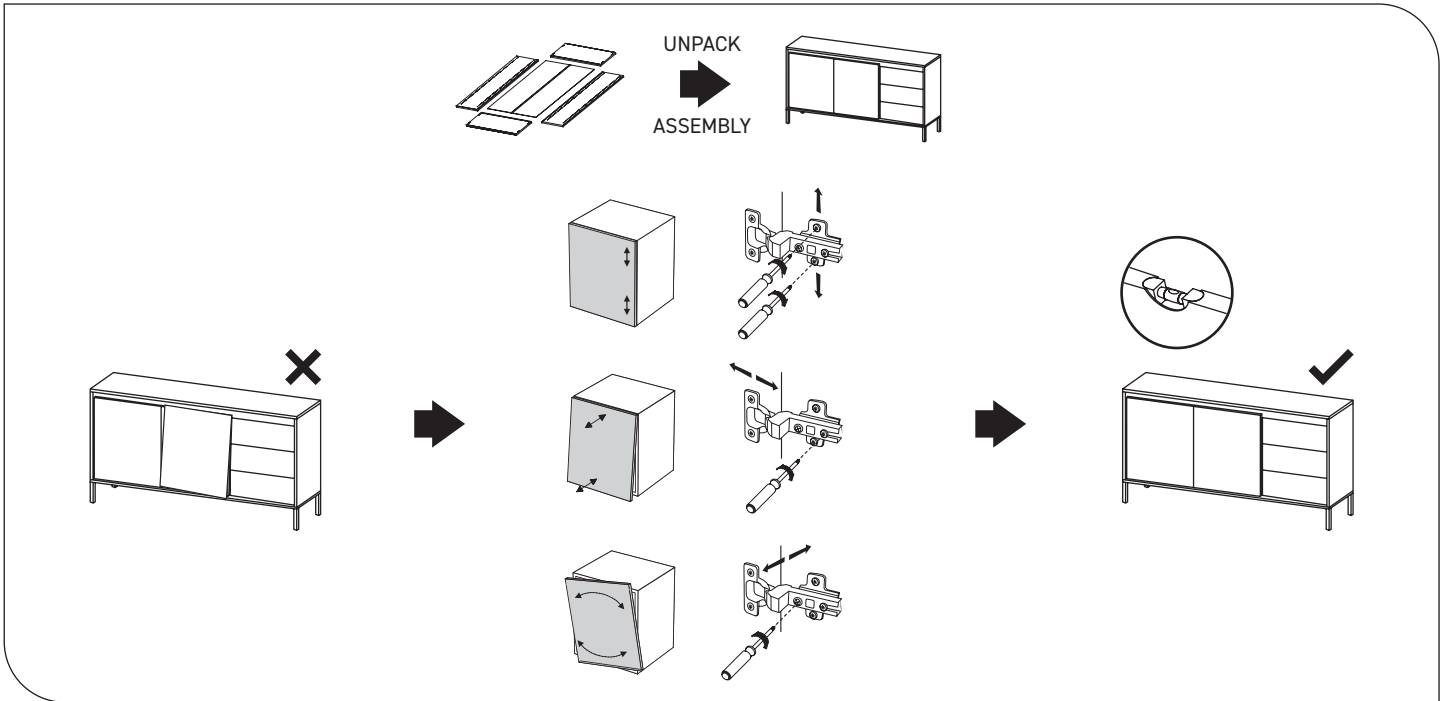
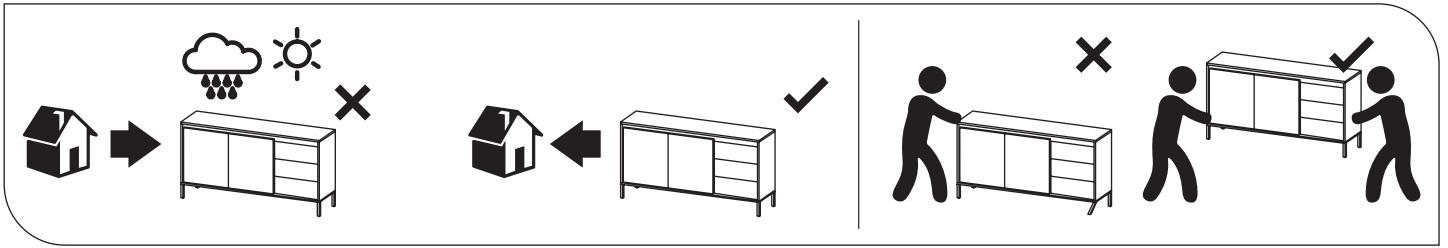

Producent - Produzent - Üretici - Producteur - Výrobce -
 Termelő - Producer - Produttore - Producător - Productor

MEBLE LASKI KACZOROWSKA SP.K.
 Laski, ul. Kępińska 21, 63-620 Trzcinica
 meble-laski@meble-laski.com.pl